



Release Guide

Release Guide

ERDAS IMAGINE 2022

Version 16.7.0

21 October 2021

Contents

About This Release	5
ERDAS IMAGINE Product Tiers	5
New Platforms	6
Windows 11 Support.....	6
Licensing	6
New Technology	7
Image Chain as the Default Raster Display Mode	7
Windows Scaling Support.....	9
Automated GCP Creation and Image Coregistration in Spatial Modeler Photogrammetry Workflows	13
New Spatial Modeler Operators	15
Add Control Points to Block.....	15
Attribute Statistics.....	15
Calculate Flow Concentration.....	15
Calculate Processing Quantity	16
Classify Features.....	16
Convolve Fuzzy Classifications	16
Define Control Points	17
Define Block Parameters For Mixed Sensor Model	17
Define Continuity Model Parameters	18
Define Focal Parameters.....	18
Generate Control Points Based On Reference.....	18
Generate Deep Learning Training Chips	19
Generate Stereo Pairs.....	19
Generate Topology Features.....	19
Get Dictionary Names	20
Get Iterator Execution Method Resources.....	20
Interpolate Using Kriging	20
Read Digital Camera Parameters From ORIMA File	21
Read Frame Camera Parameters From ORIMA File.....	21
Read Image Parameters For Mixed Sensor Model.....	21

Updated Spatial Modeler Operators	22
Associate Georeference	22
Cell Area/Cell X/Cell Y/Orthorectify	22
Compute Transform	22
Convert	23
Convert to Features.....	23
Convert to Raster	25
Create SGM Point Cloud.....	26
Custom Matrix Input	27
Define Adjustment Options For Orbital Pushbroom Model	28
Define Image Parameters For Rational Function Model	28
Define Mosaic Input Options	29
Define Point Match Options.....	29
Dictionary Item	30
GeoPackage, File Geodatabase, and CSV support in Features Input and Features Output	30
Get JPEG 2000 Options	31
Spatial Model Editor Interface Improvements	31
Reorganized Spatial Modeler Ribbon Tab	31
Search a Model For An Operator	31
The Mouse Cursor Reflects if a GUI is Available.....	32
Open Non-spatial Model/Operator Outputs in a Dialog	32
Connect Two Widely Separated Operator Ports.....	32
Align Operators Functions.....	33
Save As to Python script	36
Center Dialogs on Same Screen as Spatial Model Editor.....	36
Format Support.....	37
Landsat 4, 5, 7, and 8 from USGS	37
JPEG 2000 NoData Mask	37
DIMAP v2.....	37
SRTM HGT	37
Esri File Geodatabase.....	37
SIDDD 1.1.....	37
NITF	37

Features from S3 Bucket.....	37
General ERDAS IMAGINE.....	38
SIPS v2.4.16	38
Inquire Box Improvements	38
Filename Case Retention	38
File Chooser Improvements	39
GPU Acceleration.....	40
Projected Coordinate Systems (PCS)	40
MosaicPro	40
SAR Functionality	41
Beta 0.....	41
Sigma 0.....	41
E-Z Coherence Change	41
Sentinel-1 GRD	41
Sentinel-1 Image Formation	41
Capella.....	41
ICEYE	41
COSMO SkyMed Second Generation (CSG)	41
System Requirements	42
ERDAS IMAGINE	42
ERDAS IMAGINE System Requirements Notes	43
Issues Resolved – ERDAS IMAGINE 2022	44
IMAGINE Essentials	44
IMAGINE Advantage	45
IMAGINE Objective.....	46
IMAGINE Photogrammetry	47
IMAGINE Professional.....	48
Spatial Modeler.....	49
ERDAS ER Mapper	50
Contact Us	51
About Hexagon.....	51

About This Release

This document describes enhancements in ERDAS IMAGINE 2022 (v16.7.0), including IMAGINE Photogrammetry (formerly LPS Core) and ERDAS ER Mapper.

ERDAS IMAGINE 2022 includes both enhancements and fixes. For information on fixes that were made to ERDAS IMAGINE, see the [Issues Resolved](#) section.

This document is only an overview and does not provide all the details about the product's capabilities. See [the product description](#), [the online help](#) and other documents provided with ERDAS IMAGINE for more information.

ERDAS IMAGINE 2022 is not available as a 32-bit version. Consequently, only two separate installers are provided: ERDAS IMAGINE 2022 64-bit and ERDAS ER Mapper 2022.

ERDAS IMAGINE Product Tiers

ERDAS IMAGINE performs advanced remote sensing analysis and spatial modelling to create added information. You can also visualize results in 2D, 3D, or video and on cartographic-quality map compositions. The core of the ERDAS IMAGINE product suite is scalable to your geospatial data. Optional modules (add-ons) provide specialized functions to enhance productivity.

IMAGINE Essentials is the entry-level image processing product for map creation and simple feature collection tools. IMAGINE Essentials enables serial batch processing.

IMAGINE Advantage enables advanced spectral processing, image registration, mosaicking and image analysis, and change detection capabilities. IMAGINE Advantage allows you to process parallel batches for faster output.

IMAGINE Professional includes a production toolset for spatial modeling and advanced spectral, hyperspectral, and radar processing.

IMAGINE Photogrammetry maximizes productivity with state-of-the-art photogrammetric satellite and aerial image processing algorithms.

New Platforms

Windows 11 Support

At the time of producing the final release candidate for ERDAS IMAGINE 2022, Microsoft Windows 11 had not been officially released to the public. However, ERDAS IMAGINE 2022 was tested using pre-release versions (21H2 Build 22000.65, 22458.1000 and 22471.1000) via the Windows Insider Program, and all issues found were addressed. It is therefore expected that ERDAS IMAGINE 2022 will work with the release version of Windows 11. An official announcement will be made regarding the support status of Windows 11 once the release version has been fully tested.

Licensing

ERDAS IMAGINE 2022 installers no longer attempt to automatically install geospatial licensing tools as part of the installer. If you wish to use geospatial licensing tools — for example, to set up a floating/concurrent license server — you must download Geospatial Licensing 2022 separately.

We strongly recommend upgrading to the newest version of Geospatial Licensing 2022. If you are unsure of your current version, refer to the Microsoft Windows Add or Remove Programs utility.

You can find the appropriate download in the [Downloads](#) section of the Hexagon Geospatial website.

New Technology

Image Chain as the Default Raster Display Mode

Image Chains are standardized models for displaying imagery via a series of linked processing steps (the chain) whose parameters are set initially by information derived from the specific file being displayed, but which can be adjusted by the user.

For example, a single band thematic image that is identified as being elevation data may display in a very different fashion than one identified as panchromatic data in the visible spectrum wavelength. The former would display using a sun-angle shaded relief rendering, while the latter would display with a more traditional DN to screen brightness stretch. Similarly, a WorldView-2 image might trigger the selection of a different set of statistical stretch and filter parameters than those used for a Pleiades image. This provides for data-specific default display styling.

For several releases now, Image Chains have been provided as an alternative to the traditional Raster mode of displaying imagery. With the release of ERDAS IMAGINE 2022, the Image Chain has been switched to be the default behavior. Consequently, if a raster file is dragged into a 2D View or is selected using the File Chooser without changing any settings in the dialog, the data will default to being displayed via the appropriate Image Chain.

Some users may still prefer to use the older Raster mode of rendering by default, and this can be switched through the Preference Editor (or via an option on the File Chooser that sets the Preference directly). In the Preference Editor, select the Viewing category and then the Viewer sub-category. Change the Default Raster Rendering Engine preference from Image Chain to Legacy and save the change if you wish to use the old mode.

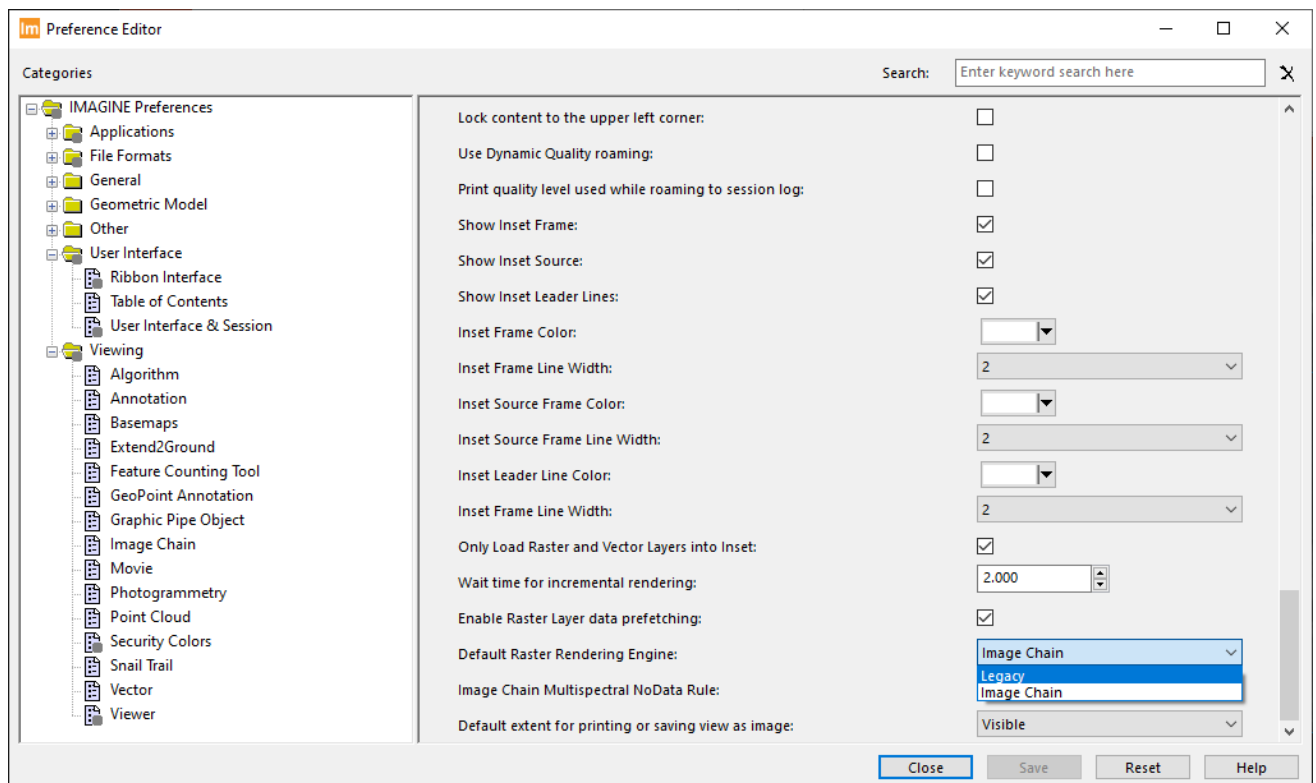

The Image Chain provides many advantages for image display. Image Chains were originally introduced for, and perhaps most benefit, users with access to data in NITF format and other defense formats where the rich

set of image metadata triggers various rules on how any given image should display by default. These are facilitated by dedicated **Image Chains called SIPS** (the Softcopy Image Processing Standard).

However, commercial customers can also benefit greatly from standard Image Chains. The primary benefit is the ease of switching between Image Chains. Using the legacy raster render, if you opened an image as Grey Scale, but then decide you really wanted to open it as Pseudo Color, you would have had to remove the image from the View and start again. This used to happen all the time with products such as an NDVI, which are generally produced as athematic data and so defaulted to Grey Scale display, but then the user wanted to try to apply a color ramp to the data and would have to redisplay as Pseudo Color. With Image Chains, you simply go to the Image Chain pull-down and select the Image Chain you wish to swap to. If your athematic NDVI defaulted to the Panchromatic chain, you could easily switch to Pseudocolor instead in order to style using a color ramp.

Other benefits include a more comprehensive Relief display for elevation data:

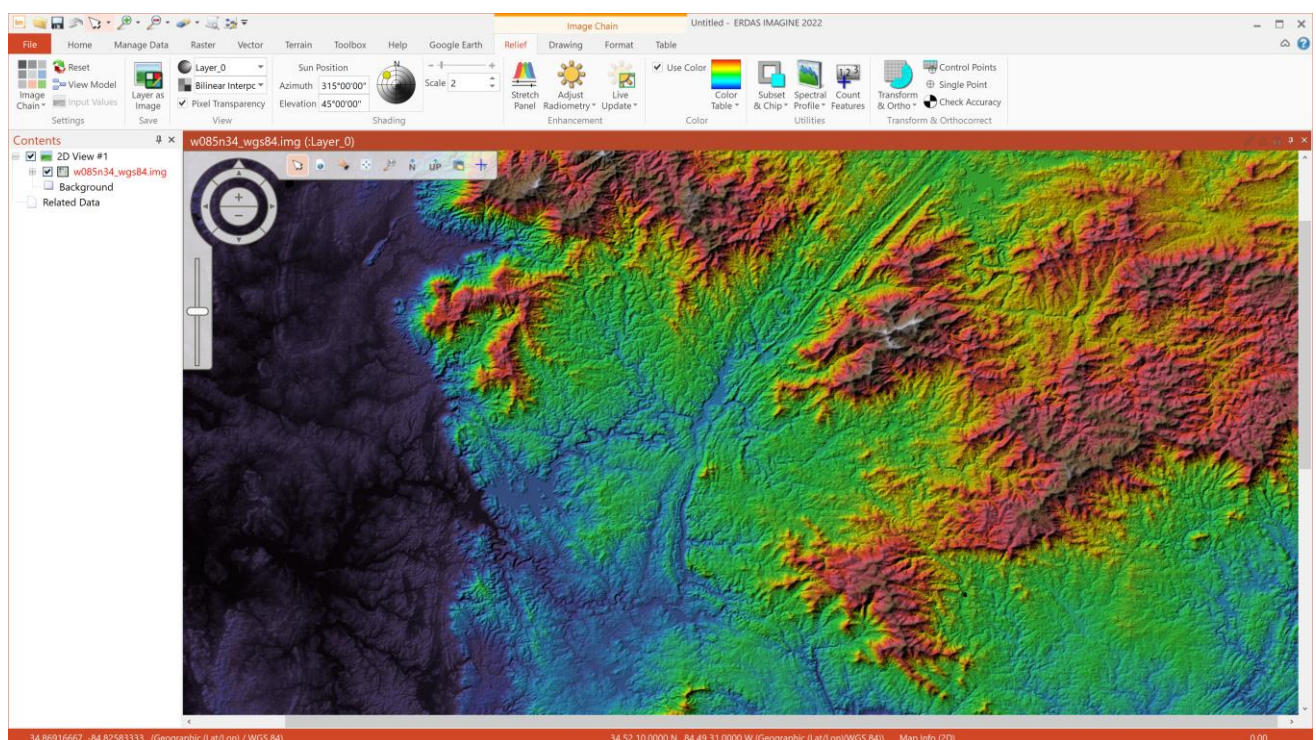

The Image Chain parameters used to style an image for display are automatically saved to the user's $\$HOME\imagine1670\ImageChainParams$ directory as .icp files. This file is then automatically used next time the file is opened as an Image Chain.

However, the styling can be easily reset to the default Image Chain parameters for a specific image file. Select the tab specific to the currently used Image Chain (e.g., Relief) and in the Settings group, press the Reset button.

Windows Scaling Support

4K monitors (usually referred to as ultra-high definition or 4K UHD), and even higher resolution devices, are now commonplace and are usually used in conjunction with the Windows Scaling option to increase the size of the user interface for human readability. ERDAS IMAGINE 2022's user interface has been significantly overhauled to natively support the Windows Scaling value. This enables increasing the relative size of the user interface while at the same time maintaining full resolution use in areas such as the 2D View, thereby providing full use of your hardware investment.

For example, if using the prior ERDAS IMAGINE 2020 version on a 4K UHD monitor (3840 columns x 2160 rows), at a Windows Scaling of 200%, not only would the user interface elements be twice as large, but the 2D View canvas would also be treated as being a lower DPI. So if the 2D View occupied 3000 x 2000 pixels of the screen, Windows would treat it as consisting of only 1500 x 1000 pixels. Consequently, an image displayed at a 1:1 screen-pixel-to-image-pixel ratio would display only 1500 x 1000 pixels from the image file (i.e., effectively, one image pixel is actually being represented by four UHD screen pixels, thereby defeating the object of having a high-definition device).

ERDAS IMAGINE 2022 is capable of scaling the user interface elements to make them legible while also maintaining the full UHD resolution of the 2D View. To use the example above again, if Windows Scaling is set to 200% and the 2D View occupied 3000 x 2000 pixels of the screen, an image displayed at a 1:1 screen-pixel-to-image-pixel ratio would display 3000 x 2000 pixels from the image file (i.e., one image pixel is truly being represented by one UHD screen pixel). You can see more of your data at once and will have crisper detail while zooming in and out.

Similarly, text elements, feature lines, etc., will be represented in sharper, crisper detail.

The following screenshots demonstrate the difference in spatial extent displayed on the same 4K UHD monitor set to 200% Windows Scaling and a Hexagon Content Program image displayed at 1:1 resolution, between ERDAS IMAGINE 2020 Update 3 and ERDAS IMAGINE 2022.

ERDAS IMAGINE 2020 Update 3:

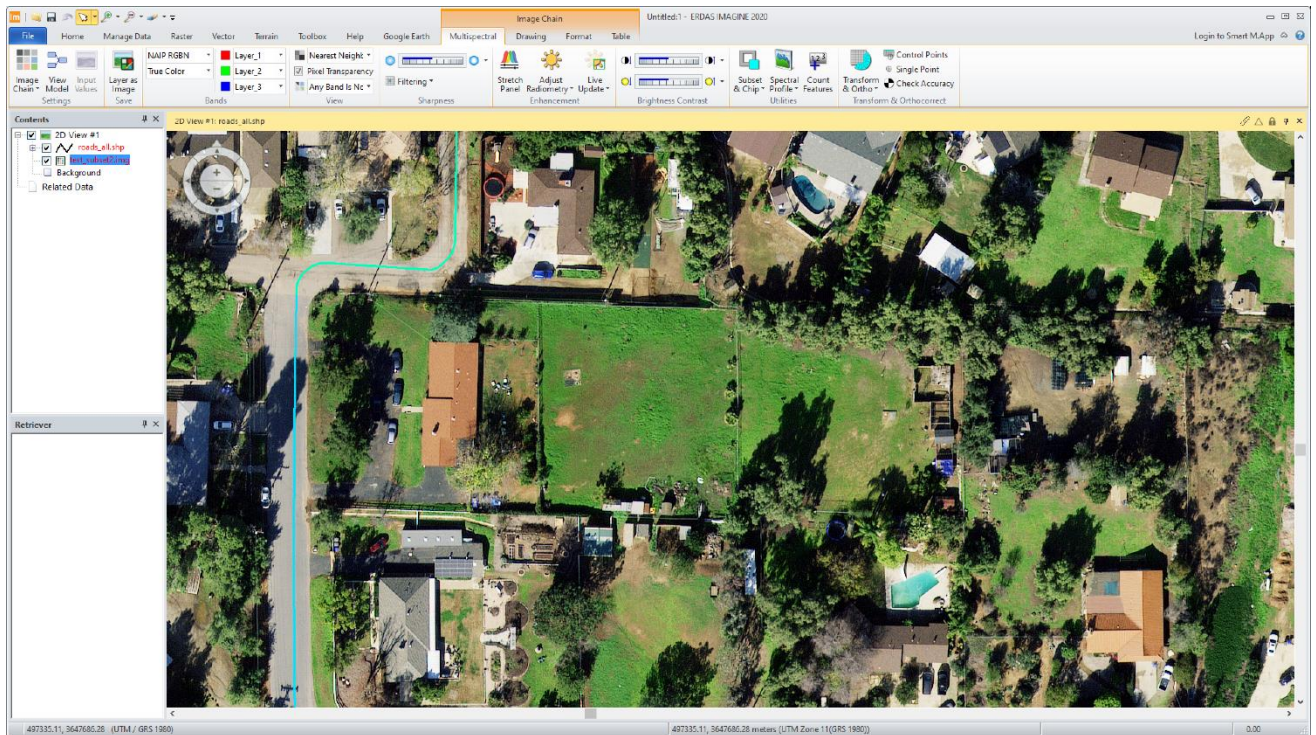

ERDAS IMAGINE 2022:

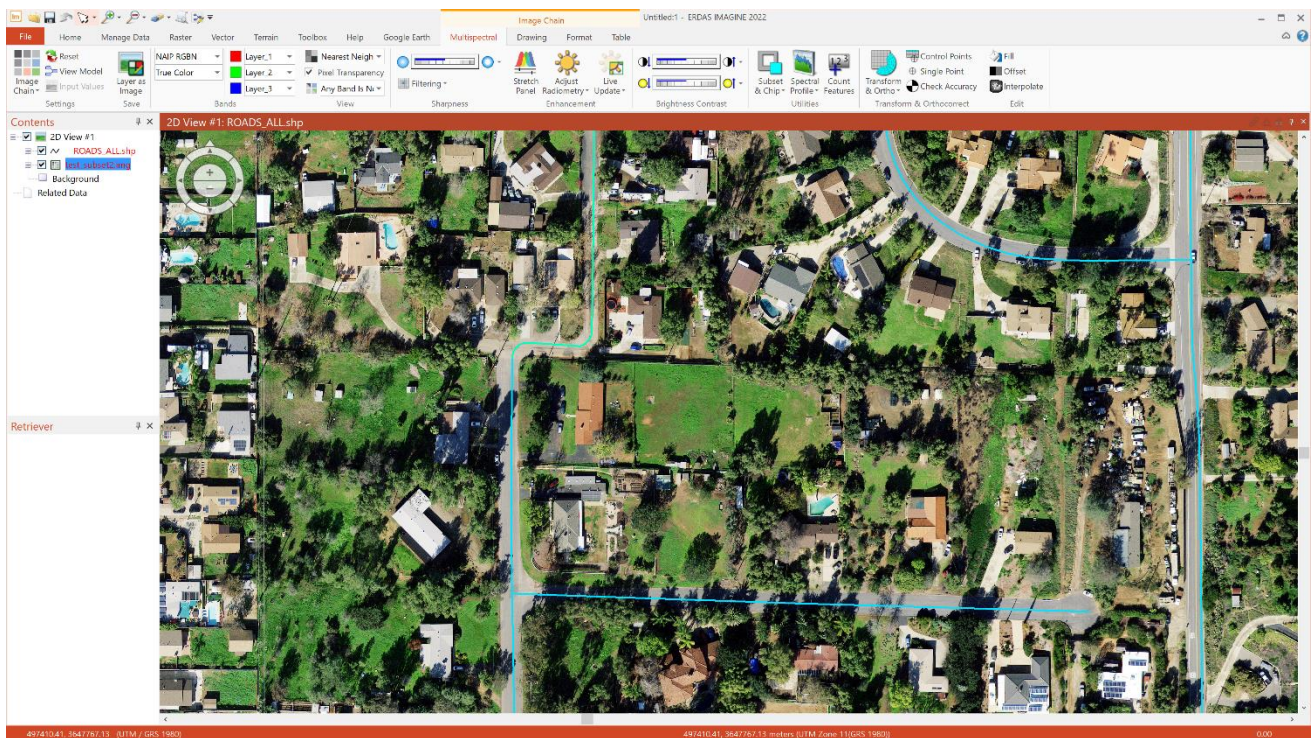

The difference in definition (especially evident in the user interface elements) can perhaps be more easily seen if we zoom in on these screenshots to show just the top left corners of the displays.

ERDAS IMAGINE 2020 Update 3 (top left corner of display), showing pixelation effects:

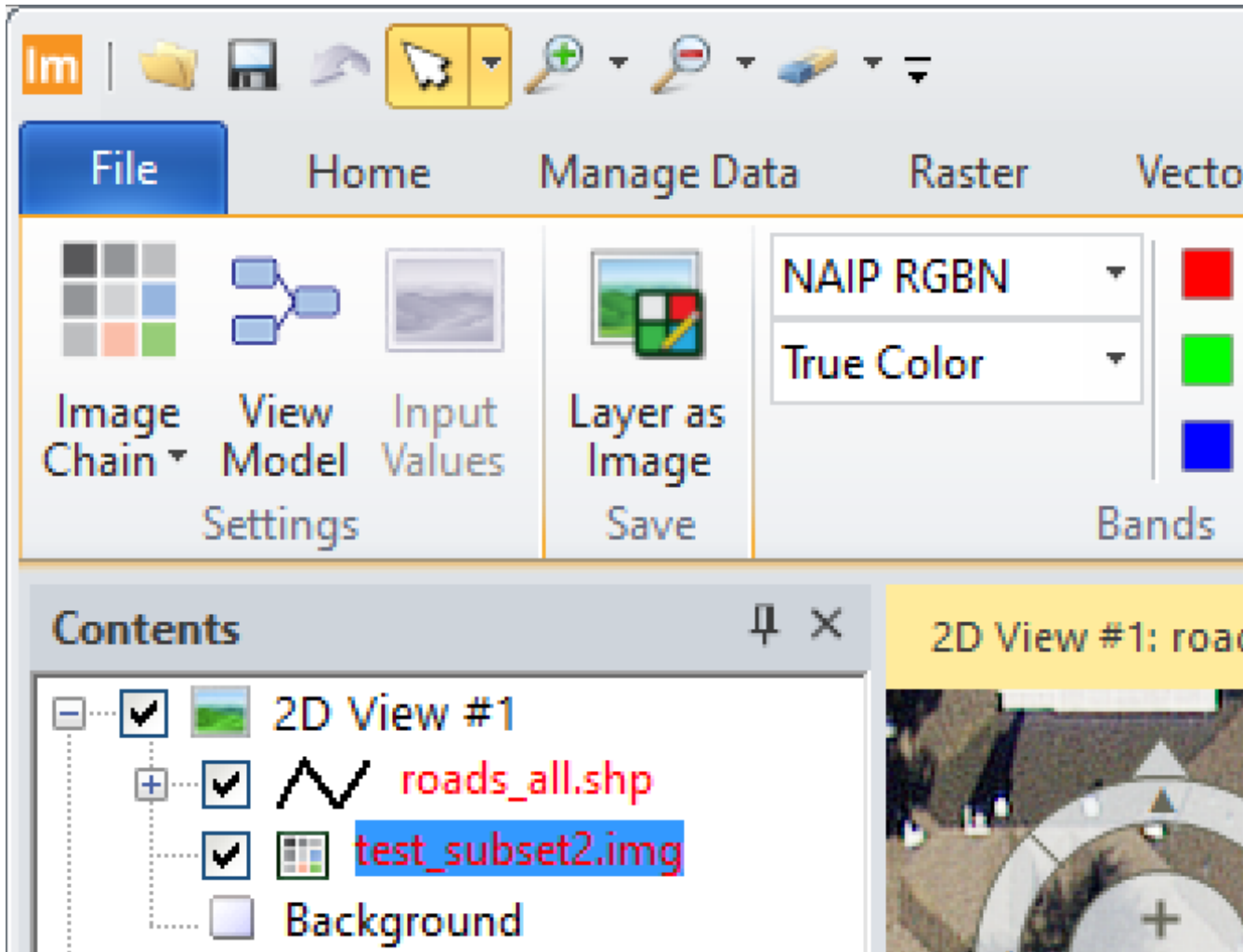

ERDAS IMAGINE 2022 (top left corner of display), showing crisper detail:

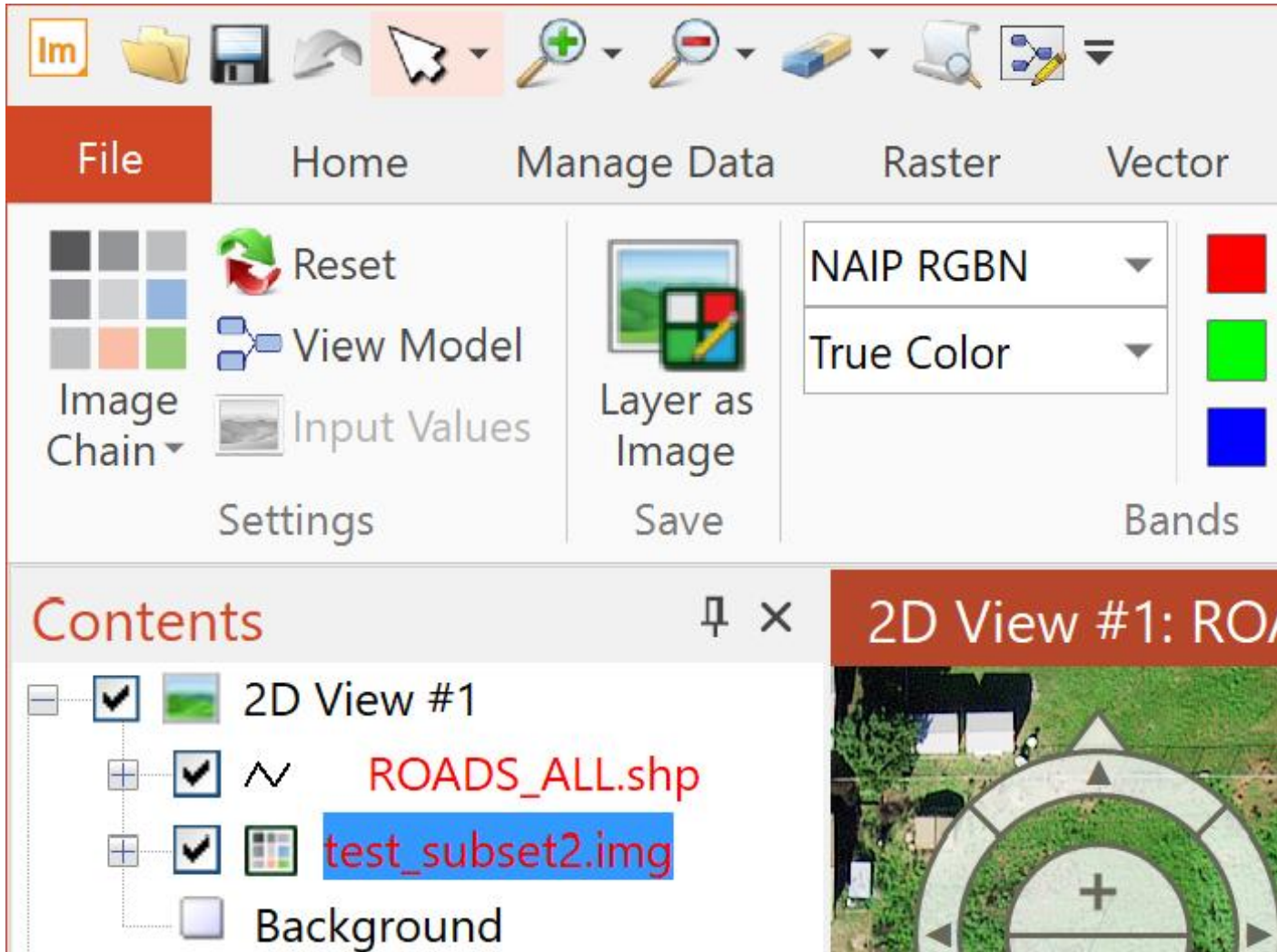

Part of the Windows Scaling Support effort also required an update to the Styles used by the Ribbon interface. Consequently, the default style for ERDAS IMAGINE 2022 will look different from prior versions and can be controlled via the Preference Editor.

Automated GCP Creation and Image Coregistration in Spatial Modeler Photogrammetry Workflows

The IMAGINE Autosync product (now a part of IMAGINE Expansion Pack) is a set of tools for performing automated image-to-image coregistration. The general premise is to have a highly spatially accurate reference image that you want other imagery to line up with. To facilitate this, control points are automatically generated matching features from the input imagery to the reference. These are then used to compute a geometric model to transform the input imagery to the same spatial accuracy as the reference. The model can be as simple as an affine, or as complex as an orbital pushbroom satellite sensor model for orthorectification.

In ERDAS IMAGINE 2022 we have added new operators to Spatial Modeler (as well as updating existing ones) to replicate this capability in spatial models, which can be used to further automate the coregistration process.

For example, here are two QuickBird images (courtesy of DigitalGlobe) that do not align closely using their basic geometry when they are overlaid and the Swipe tool is activated:

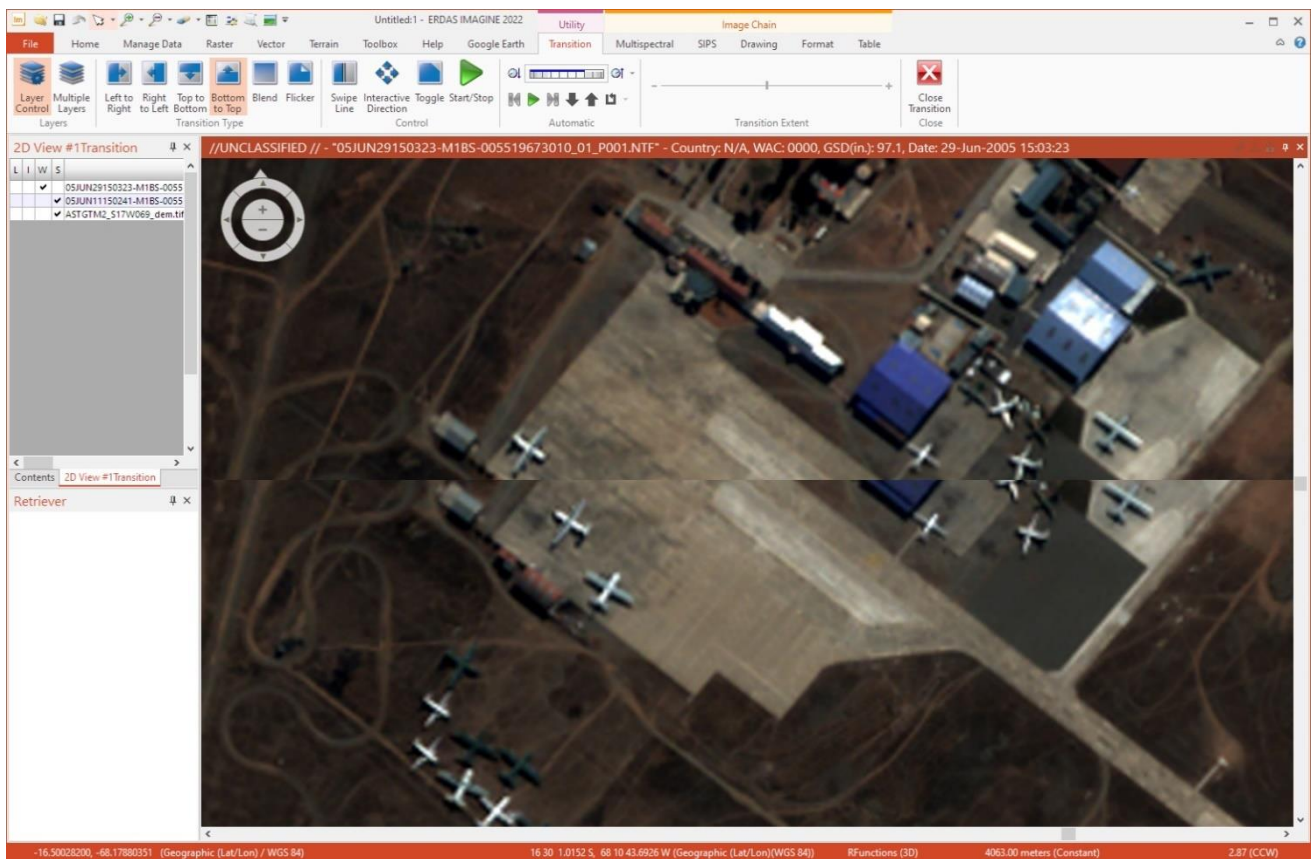

The following Spatial Model was constructed to take the data, treat one image as the reference, and generate ground control points automatically to tie the other image to the reference. Those GCPs are then used to update the Rational Functions (RPCs) and can be used either to produce an ortho-rectified output file or to very quickly create a proxy header for the original image to more accurately position it.

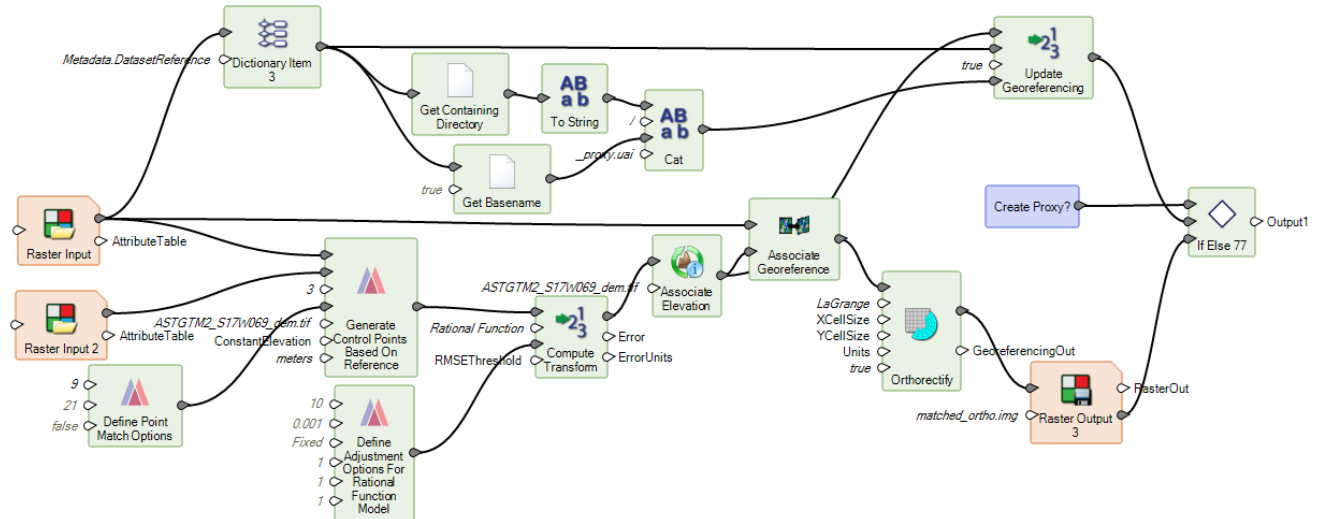

The result is two images that overlay and Swipe much more accurately. It's actually almost impossible to see the difference between the two images except where an airplane has been moved between the two dates the images were captured:

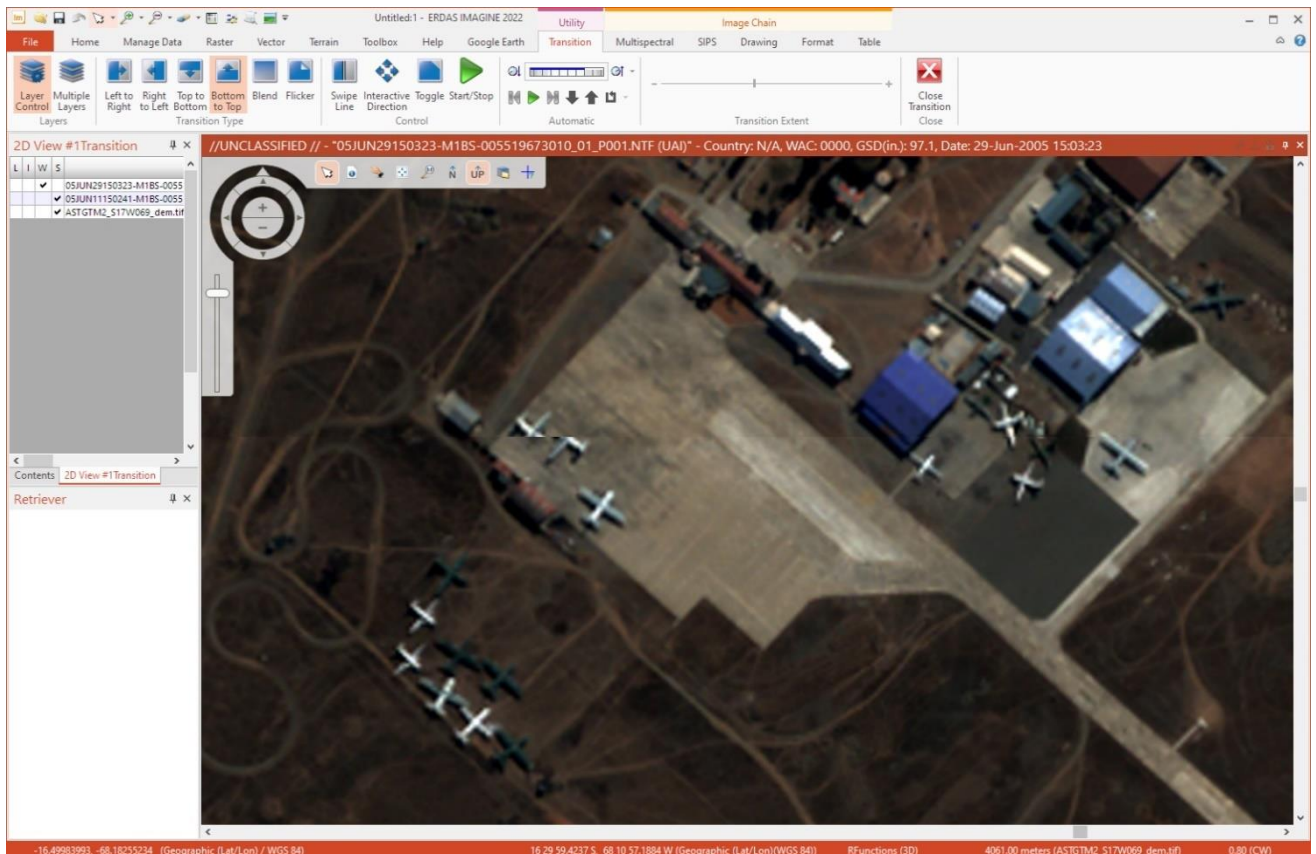

New Spatial Modeler Operators

Note that many of these new operators require additional licensing in order to run as part of a spatial model execution. This is generally noted in the Help for each operator.

Add Control Points to Block

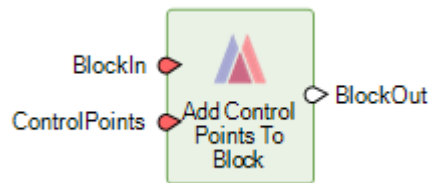

The Add Control Points to Block operator adds control points to a block. The added control points could be used in Run Bundle Adjustment where the block is used as input.

Attribute Statistics

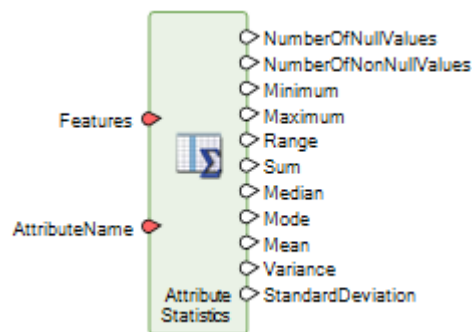

This operator computes basic statistics for a numeric attribute of the input features.

Calculate Flow Concentration

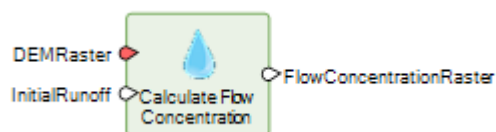

Note: This operator requires IMAGINE Advantage, IMAGINE Professional, GeoMedia Advantage, or GeoMedia Professional licenses in order to run.

Calculate Flow Concentration operator is part of a collection of operators for hydrological analysis. It predicts stream paths, with runoff being assumed to flow downhill from pixel to pixel. It is assumed that all runoff drains as overland flow and that none of it is absorbed or evaporated. Runoff is usually considered water from rain, snow-melt, and other sources.

Calculate Flow Concentration operates on a raster of continuous surface elevation data, such as a Digital Elevation Model (DEM). The DEM Raster controls the downhill path through each pixel. The downhill direction is the steepest slope out of the pixel (i.e, the greatest downhill elevation change leading out of the pixel into the eight adjacent pixels). If two or more adjacent pixels have the same lowest value, then the flow is divided evenly among them. If none of the adjacent pixels is lower, then flow stops. Each pixel of the Flow Concentration Raster represents the amount of runoff passing through a pixel.

Calculate Processing Quantity

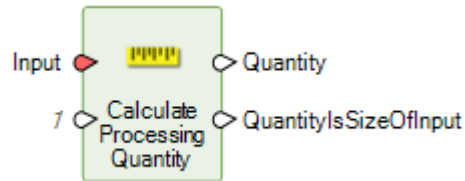

The quantity computed by Calculate Processing Quantity is useful for constructing high-performance spatial models. Given an input, the operator uses the supplied maximum available resources, typically obtained from the Get Iterator Execution Method Resources operator, to compute a quantity that allows the input to be processed in a number of iterations that matches those resources.

The computed quantity is intended to be used with a data-dividing operator appropriate for the input type. Thus, the units of the quantity are dependent on the input type. For example, if the input is `IMAGINE.Raster`, the computed quantity is intended to be used as the `SizeLimit` input to the Create Dice Boundaries operator and, thus, the units are bytes.

Classify Features

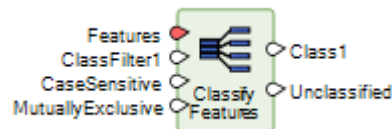

This operator classifies features by applying multiple attribute-based filters that assign them to corresponding classes.

Convolve Fuzzy Classifications

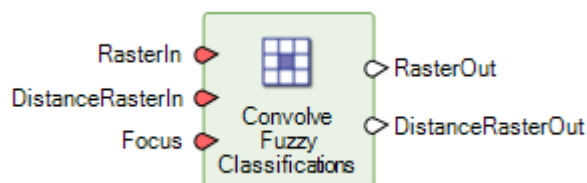

The Convolve Fuzzy Classifications operator computes a single-band classification using a convolution-based algorithm and fuzzy inputs. This operator supports GPU acceleration.

Tools such as ERDAS IMAGINE's Supervised Classification dialog can produce fuzzy classifications. A traditional classification is one where a single band thematic classification is produced (with an optional corresponding distance image) where each pixel is coded as the most likely (shortest distance) class value at that location. The optional distance file can be used to threshold low-confidence (large distance) locations to a background or NoData assignment. But there is only ever a single possible class per pixel. Conversely, a fuzzy classification extends this concept by producing n thematic bands of classified values where the second band represents the second most likely class at the pixel location, the third band represents the third most likely class at the pixel location, etc. Similarly, the distance image contains n continuous bands, where the second band represents the distance of the class value assigned in the second thematic class image, etc. These additional bands of classification and distance are generally intended for further analysis and processing to produce a final single-band classification.

The Fuzzy Convolution operation creates a single-band classification by calculating the total weighted inverse distance of all the classes in a window of pixels and assigning the center pixel the class with the largest total inverse distance summed over the entire set of fuzzy classification bands. This has the effect of creating a context-based classification to reduce the speckle, or "salt and pepper," in the classification.

Original classes with a very small distance value remain unchanged, while classes with higher distance values may change to a neighboring value if there are a sufficient number of neighboring pixels with class values and small corresponding distance values.

Define Control Points



This operator defines a dictionary of control points based on input features that represent ground points, image names, and image points. A control point is a point with known or unknown ground coordinates and one or more associated image locations. A ground control point (GCP) is a control point with known ground coordinates.

Control Points can subsequently be used for purposes such as solving a geometric model and orthorectifying an image.

Define Block Parameters For Mixed Sensor Model

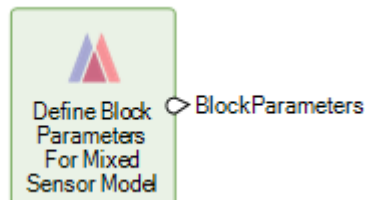

This defines the dictionary needed to create a Mixed Sensor block. No user input is necessary; the operator is simply creating the required dictionary.

The Mixed Sensor uses the existing 3D geometric model associated with each given image. In order to be used in a Mixed Sensor block, the interior and exterior orientation of an image must be resolved. Images falling into this category include calibrated images, oriented images, SOCET SET support files with known 3D geometric models, or any images with a 3D geometric model automatically recognized by ERDAS IMAGINE. Images in a Mixed Sensor block could be used for photogrammetric operations such as ortho rectification and mosaicking.

Define Continuity Model Parameters

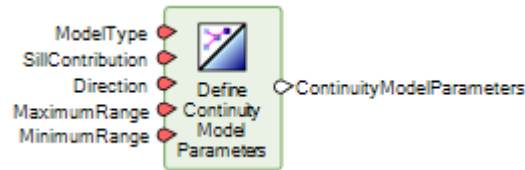

This operator defines the parameters of a continuity model to be used by the Interpolate Using Kriging operator.

Define Focal Parameters

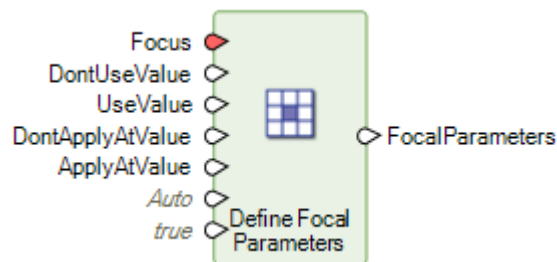

Many focal operations (such as Convolve Fuzzy Classifications) can be constrained to apply only at target pixel locations with specific classes (DN values) or to consider only certain classes (DN values) in the moving window centered on the target pixel. To facilitate defining such constraints, the Define Focal Parameters operator can be used to create a dictionary of the desired parameters. As such, the Define Focal Parameters operator does not apply any processing itself, other than to create the dictionary of focal parameters.

Generate Control Points Based On Reference

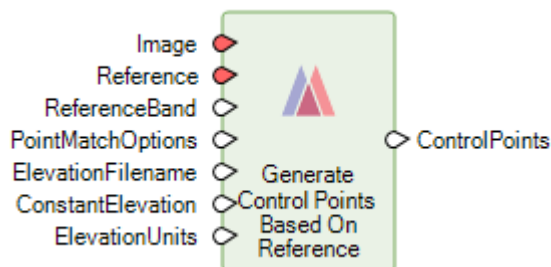

Note: This operator requires IMAGINE Expansion Pack licenses in order to run.

This operator generates control points by automatically identifying common locations between an image and reference imagery.

Generate Deep Learning Training Chips

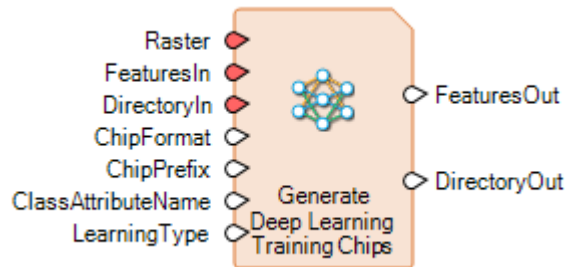

This operator creates training chips suitable for use in Deep Learning-based operators. The training chips are created from a raster stream containing the pixels for the samples and a feature stream describing the locations and class names of the training samples in the raster stream. The geometries in FeaturesIn must be area geometries whose bounding box will be used for subsetting the raster to generate the training chips. The exact bounding box will vary based on LearningType.

The areas denoted by the geometries should be relatively small (e.g., 256 X 256 pixels) and approximately square to be most useful to the deep learning algorithm. If the sample areas are large, they should be broken up into smaller pieces. For example, to indicate a river area, several small patches containing the river should be used rather than a single geometry covering the entire river.

Generate Stereo Pairs

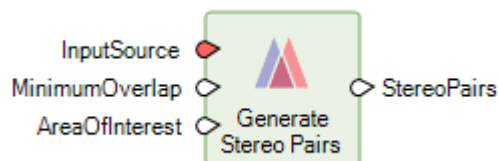

The Generate Stereo Pairs operator generates a list of images from a block or list of oriented rasters that form stereo pairs. Stereo pairs can be used in other operators for tasks such as deriving a point cloud.

Generate Topology Features

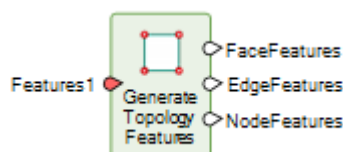

The Generate Topology Features operator generates new features representing the topological base elements (faces, edges, and nodes) derived from all input area, line, point, and vector features.

Get Dictionary Names

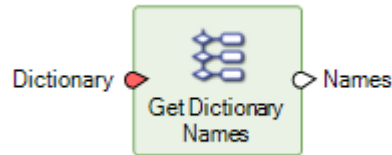

An IMAGINE.Dictionary consists of pairs of data: unique names (representing keys) and the corresponding values for those names. The Get Dictionary Names operator takes in a dictionary and produces a list of all the unique names present in that dictionary.

For example, if you wished to know the names of all the attribute fields present in a thematic raster, you could use the Get Dictionary Names operator to generate the list in this manner:

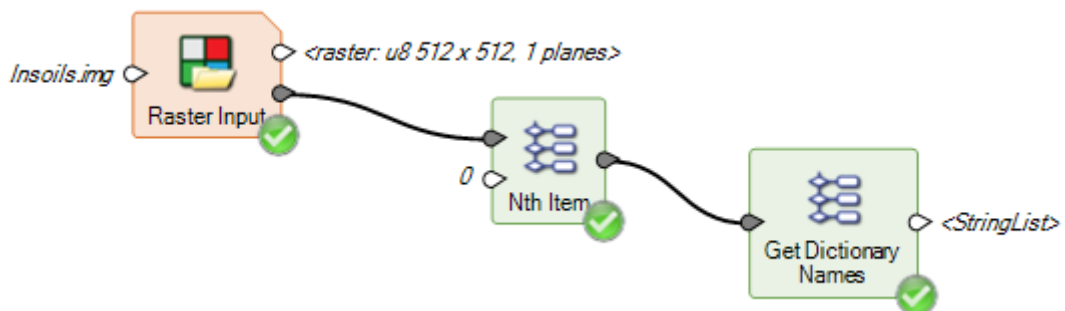

Get Iterator Execution Method Resources

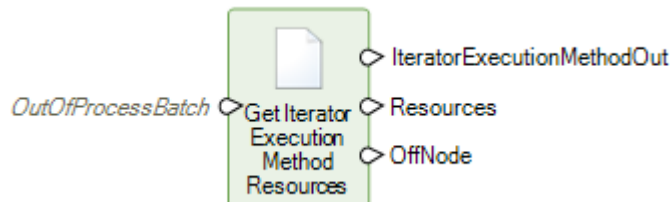

The resources value determined by Get Iterator Execution Method Resources may be useful for constructing high-performance spatial models when used in conjunction with Calculate Processing Quantity.

Interpolate Using Kriging

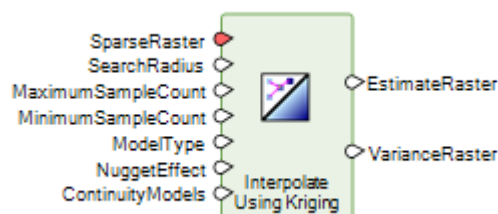

Note: This operator requires IMAGINE Advantage, IMAGINE Professional, GeoMedia Advantage, or GeoMedia Professional licenses in order to run.

This operator takes a raster of sparse data and uses an ordinary kriging operation to estimate the unknown data values.

Read Digital Camera Parameters From ORIMA File

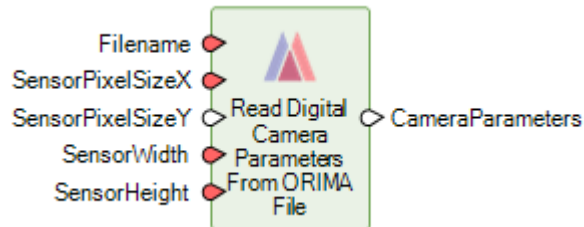

Reads digital camera parameters needed to set up a digital camera from an ORIMA camera file.

Read Frame Camera Parameters From ORIMA File

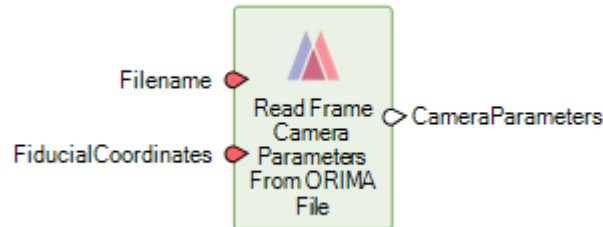

Reads frame camera parameters needed to set up a frame camera from an ORIMA camera file.

Read Image Parameters For Mixed Sensor Model



Reads the existing geometric model associated with a given image file and returns a dictionary containing the image name. The model associated with the image must support the ground-to-image 3D transformation: for example, a DIMAP image with associated RPCs.

Updated Spatial Modeler Operators

Associate Georeference

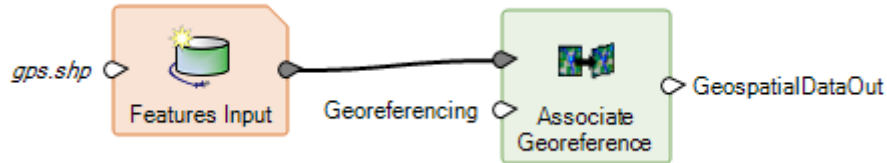

The Associate Georeference operator has been enhanced to support features as input. The operator associates georeferencing information with a raster or features, replacing all or in part any information that had previously been associated.

Cell Area/Cell X/Cell Y/Orthorectify

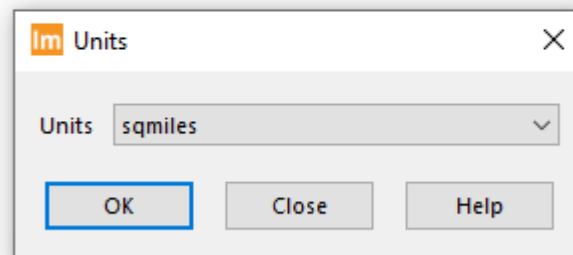
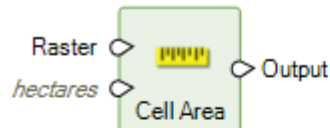

The Units port on these four operators has been updated with a dialog that provides a picklist of the acceptable values rather than relying on the user knowing what the values might be and manually typing them into the Properties panel.

Compute Transform

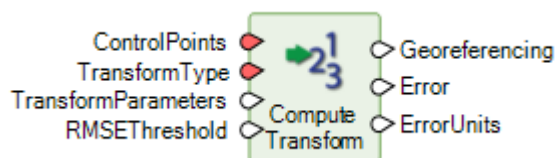

This operator takes control points and their measurements in an image and creates a transform from the image coordinate system to the control point coordinate system.

It has been enhanced with a new RSMETHreshold port. If the RMSE error computed for the output transform exceeds the RMSEThreshold, the operator execution will fail.

It has also been enhanced to support Rational Function and Orbital Pushbroom as TransformTypes for performing orthorectification.

Convert

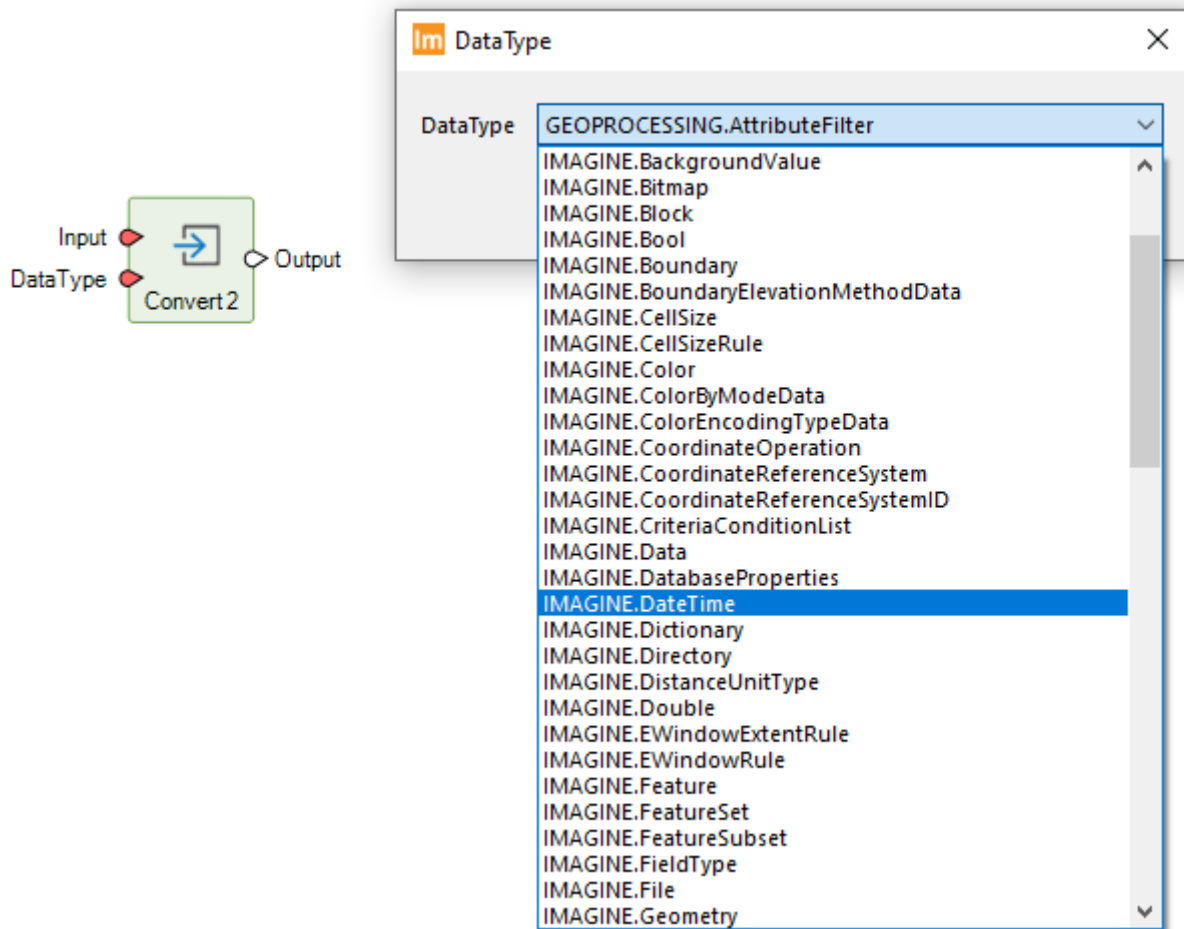

The DataType port on this operator has been updated with a dialog that provides a picklist of the acceptable values rather than relying on the user knowing what the values might be and manually typing them into the Properties panel.

Convert to Features

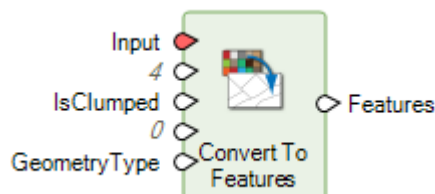

The Convert to Features operator has been enhanced to allow a raster input to be converted to point features (one point per pixel), maintaining DN values and attributes from the raster as additional attribute fields in the features.

This type of conversion is useful in many scenarios, but one of the most common is creating training data for the machine learning operators in Spatial Modeler. The machine learning operators in Spatial Modeler largely work only with attribute information (any geometries are not themselves used — it's simply a large table of

numbers to find patterns in) and needs lots of data from which to learn. If you want to train based on attributes derived from an image, you really want a point per pixel for "known training." But generally, when you are trying to train a classifier, you have polygonal training data. You know which field boundaries contain which arable crops, which segments contain water, etc. Like this:

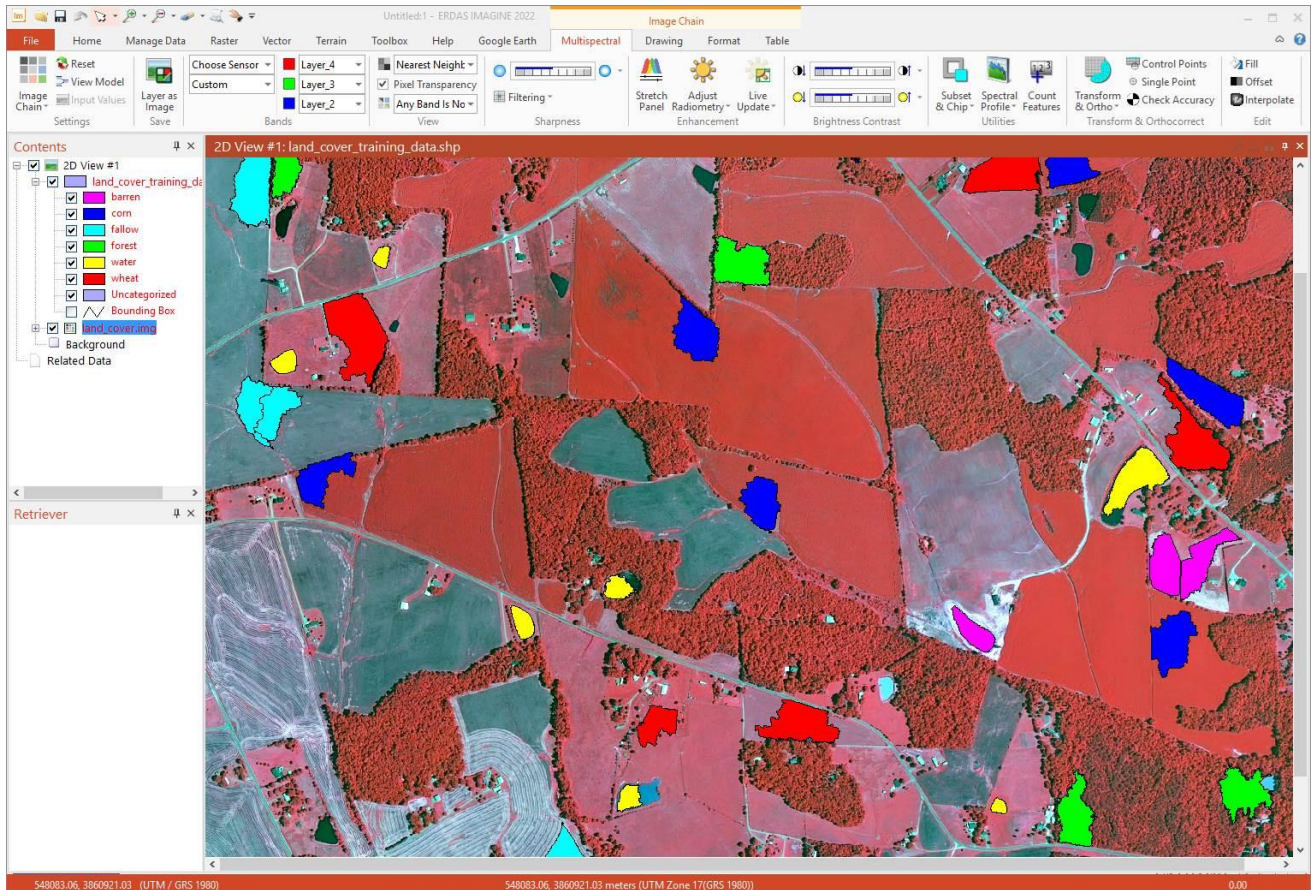

Every pixel that falls within, say, a "forest" polygon represents numerical information (the per-band DN values) that can be used to train a machine learning classifier on what characteristics are representative of "forest." But the polygon is only a single feature in the features database, so if you attempted to use the above forest polygons (area geometries) to train a Random Forest classifier, you'd only have 5 or so entries in the features from which to learn. You would have to use attributes that were the mean and SD (or other statistical measures) of all the pixel values that fell in each of the five forest polygons.

Converting the image pixels that fall within the polygon directly to attributed point features provides a very efficient means of generating the necessary training data.

Convert to Raster

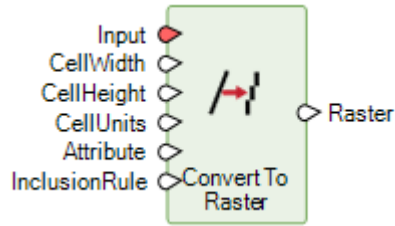

The Convert to Raster has been re-implemented (and the old version deprecated) to provide greater and more predictable control over which pixels will be included.

This includes a new InclusionRule port allowing the pixel inclusion rule for area geometries to be swapped between the old (and still default) “Vertex or half pixel edge” rule and a new “Center of cell” rule.

- **Vertex or half pixel edge** – a pixel is included if it contains a vertex or if at least half of one of the pixel's four edges lies within or on the boundary of the area geometry.

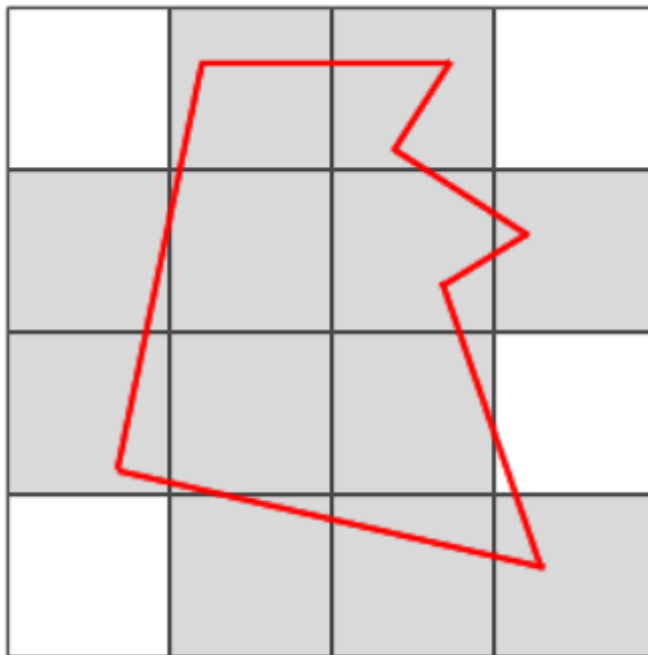

Area Geometry Inclusion Rule
Vertex or half pixel edge

- **Center of cell** – a pixel is included if its center falls within or on the boundary of the area geometry.

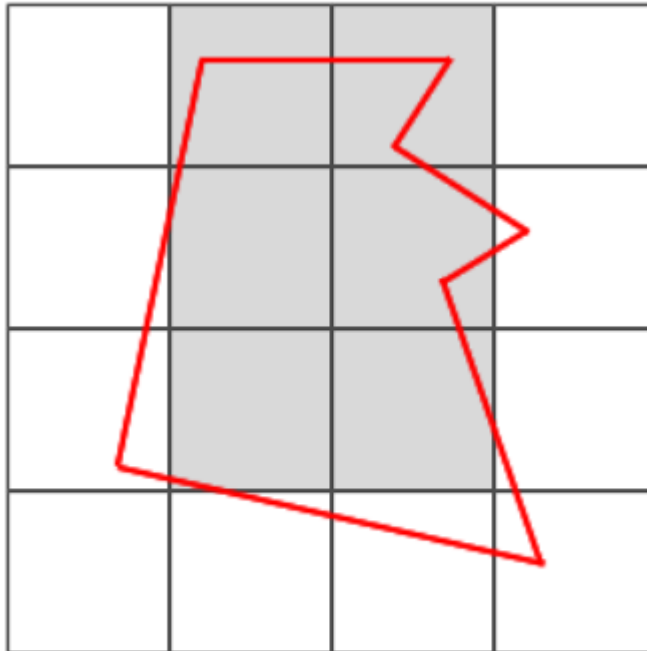

Area Geometry Inclusion Rule
Center of cell

Any pixels that are not included in the geometry are set to NoData.

Create SGM Point Cloud

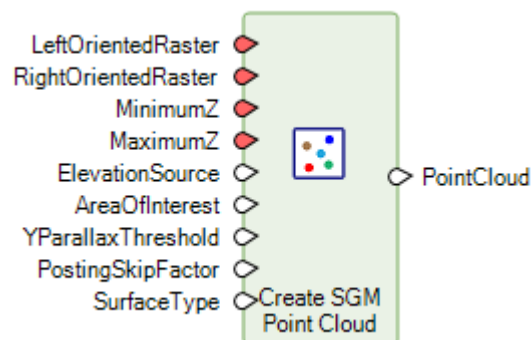

Note: This operator requires an IMAGINE DSM Extractor license in order to run.

The Create SGM Point Cloud operator extracts a dense point cloud from a pair of stereo images using Semi-Global Matching (SGM). The input images must have associated 3D model information and be in the same CRS.

The operator has been enhanced by adding a new SurfaceType port. The port can be used to specify whether to generate a sharp or smooth surface.

Smooth surfaces are generally open landscapes that are characterized by gradual changes in the terrain with few or no human-made structures, while sharp surfaces are those that have significant human-made structures built on them (such as urban areas).

Custom Matrix Input

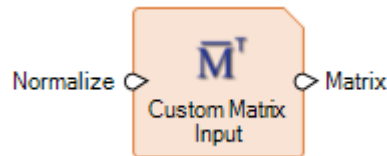

The Custom Matrix Input operator's Matrix Source dialog has been updated to have options similar to those provided by the Raster tab > Supervised menu > Fuzzy Convolution dialog to assist in defining cell values for distance weighted kernels.

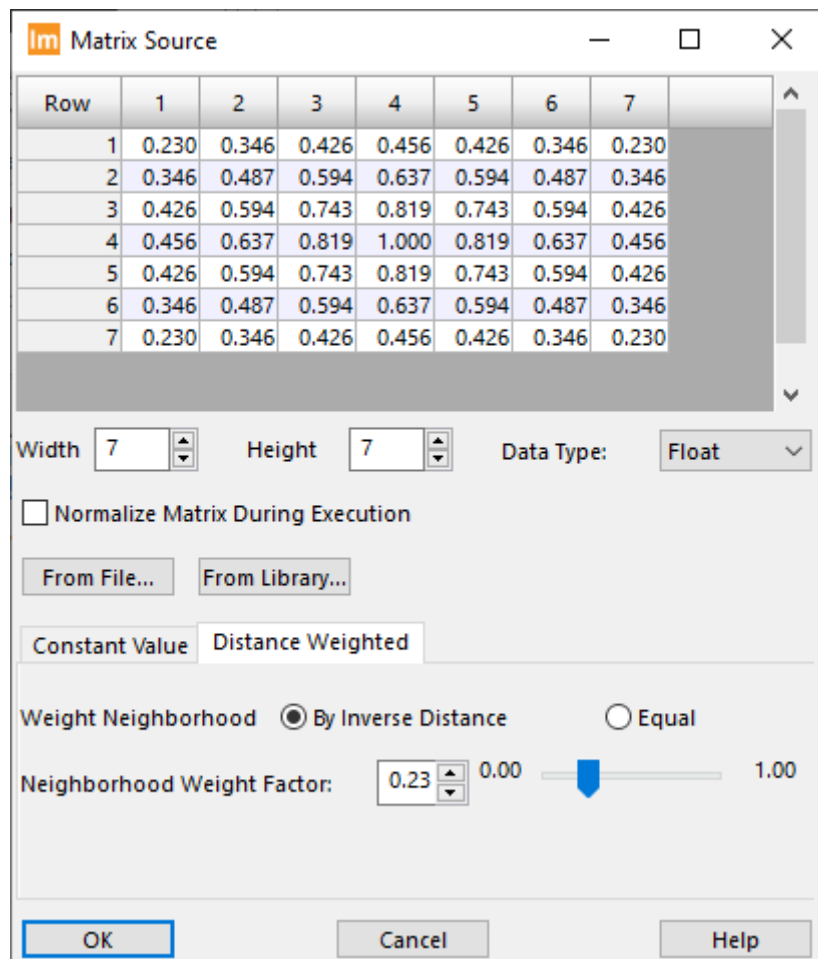

Row	1	2	3	4	5	6	7
1	0.230	0.346	0.426	0.456	0.426	0.346	0.230
2	0.346	0.487	0.594	0.637	0.594	0.487	0.346
3	0.426	0.594	0.743	0.819	0.743	0.594	0.426
4	0.456	0.637	0.819	1.000	0.819	0.637	0.456
5	0.426	0.594	0.743	0.819	0.743	0.594	0.426
6	0.346	0.487	0.594	0.637	0.594	0.487	0.346
7	0.230	0.346	0.426	0.456	0.426	0.346	0.230

Width: 7 Height: 7 Data Type: Float

Normalize Matrix During Execution

From File... From Library...

Constant Value Distance Weighted

Weight Neighborhood: By Inverse Distance Equal

Neighborhood Weight Factor: 0.23 (slider from 0.00 to 1.00)

OK Cancel Help

Define Adjustment Options For Orbital Pushbroom Model

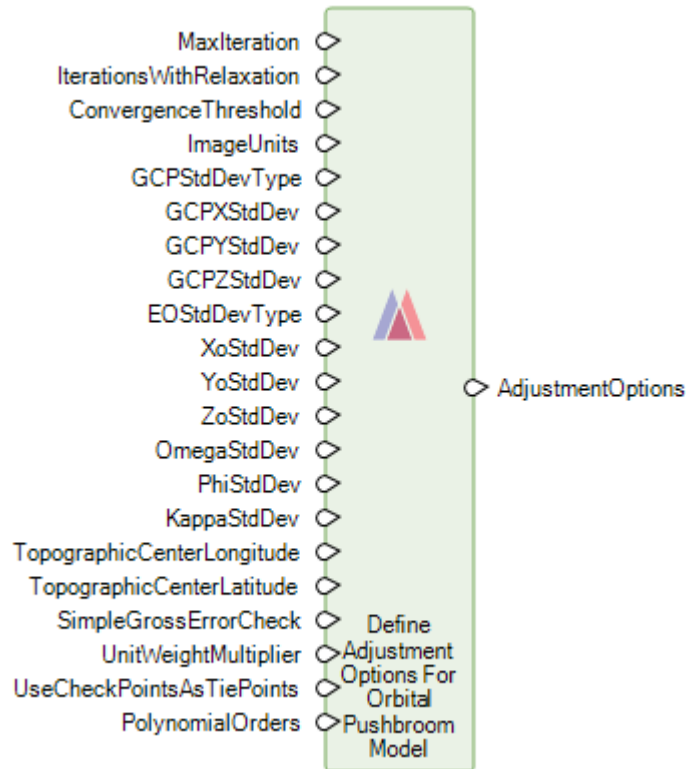

This operator assembles the options that can be used to affect the results of the bundle adjustment process when run on orbital pushbroom model blocks.

The operator has been enhanced by adding a new PolynomialOrders port. The polynomial orders are used for the six exterior orientation parameters in the adjustment model. These should be specified in the order X, Y, Z, Omega, Phi, Kappa and will override any image-specific orders that have been specified.

Define Image Parameters For Rational Function Model

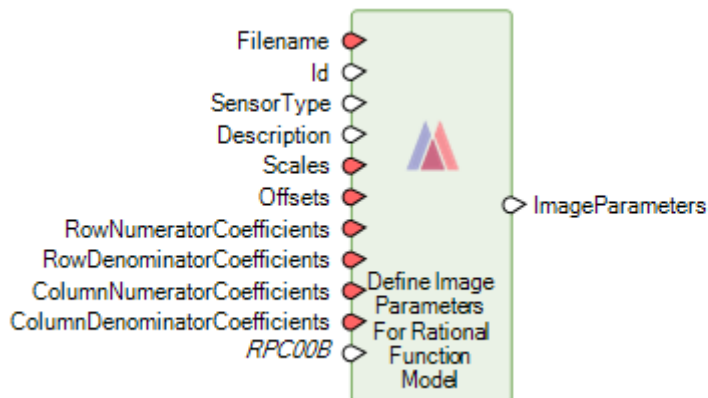

The CoefficientOrder port has been updated to enable the RPC coefficients to be defined in either the form native to ERDAS IMAGINE or that used by the RPC00B definition.

Define Mosaic Input Options

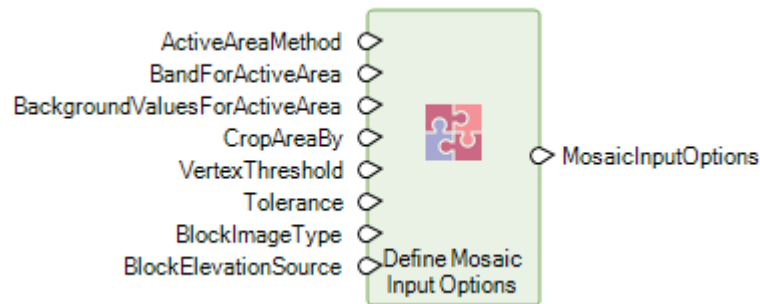

The Define Mosaic Input Options operator defines input options used with the Mosaic Images operator.

Two new ports, VertexThreshold and Tolerance, have been added to it.

When the active area of an image is computed using the Edges method, the computed active area polygon will have as many vertices as necessary to accurately describe the active area boundaries. A possible drawback of the Edges method is that the computed active areas can be complex with a large number of vertices, which impacts the performance of the mosaicking process. In most cases, such accuracy is unnecessary, and the active area polygon can be simplified to have fewer vertices safely. The simplification is controlled using the newly added ports.

Define Point Match Options

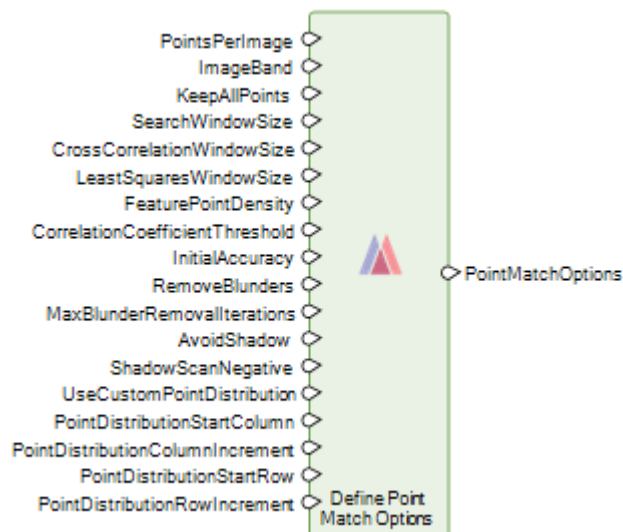

This operator defines the point match options to be used with point generating operators such as Generate Tie Points and Generate Control Points Based On Reference.

The operator has been enhanced by adding several new ports for specifying options. These new ports can be used for point generation with Generate Control Points Based On Reference operator.

Dictionary Item

The Dictionary Item operator's Select Dictionary Items dialog has been updated with a Search field to make it far easier to find the specific Key/Value parameter you are looking for.

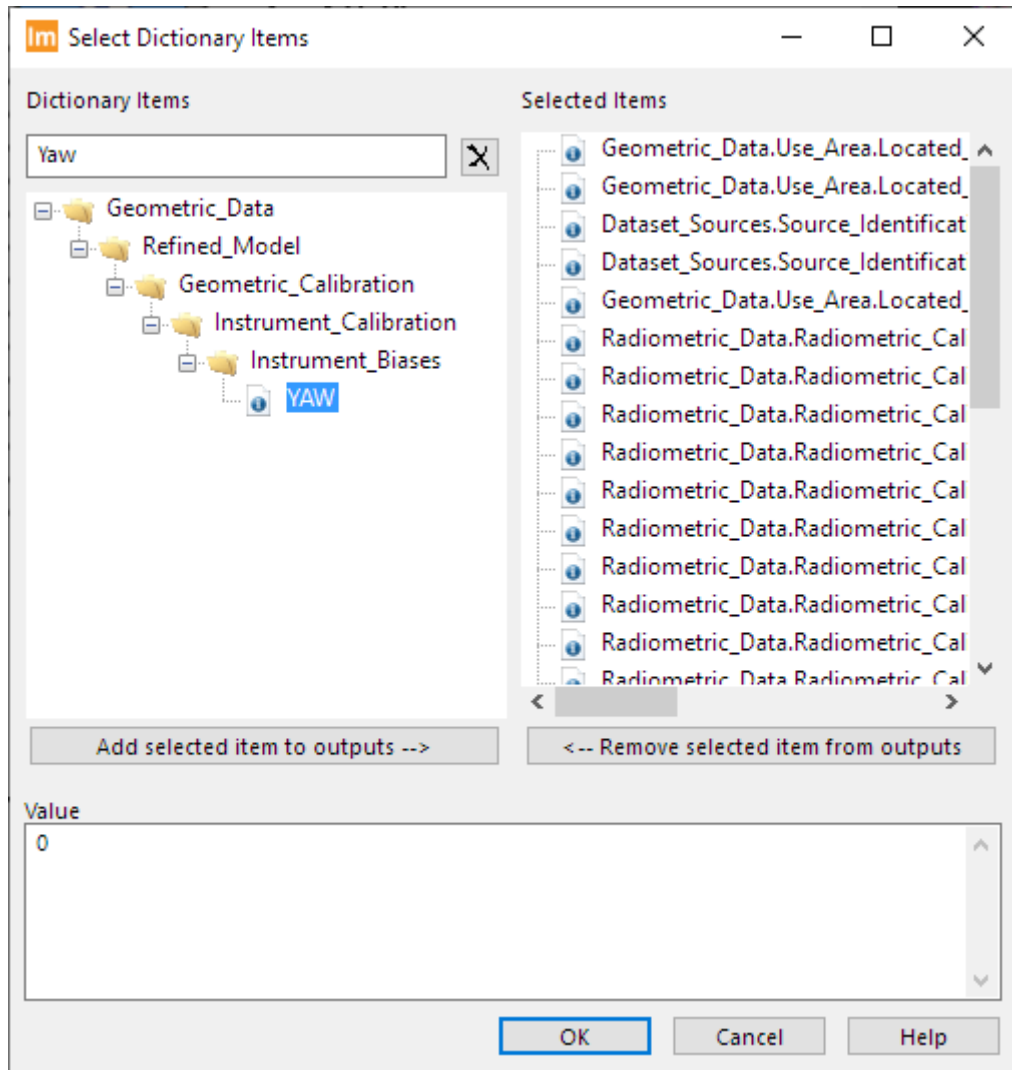

GeoPackage, File Geodatabase, and CSV support in Features Input and Features Output



The GeoPackage and File Geodatabase formats are now supported for input and output of Features data in Spatial Modeler.

CSV support has also been improved to support WKT geometry definitions.

Get JPEG 2000 Options

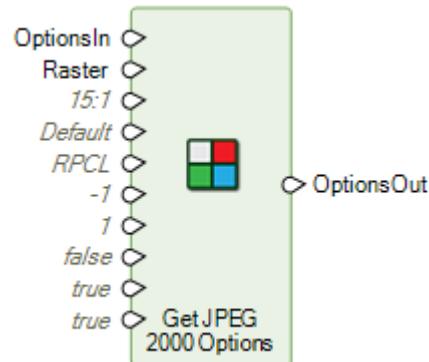

A new IncludeMaskChannel port enables definition of whether or not to include a mask channel (representing NoData locations) in the output image file if it is written to the JPEG 2000 (JP2) format.

Spatial Model Editor Interface Improvements

The Spatial Model Editor has been enhanced with various new features to assist in the creation, editing, and update of complex Spatial Models. These include the following:

Reorganized Spatial Modeler Ribbon Tab

The Spatial Modeler Ribbon tab has been reorganized to better accommodate the newly added buttons, which support the following features. The Find and Align tools have been added to the Editing group. The various options for showing and hiding elements of the graph have been moved a Show pulldown, and a new Library group that provides a list of links to useful references has been added.

Search a Model For An Operator

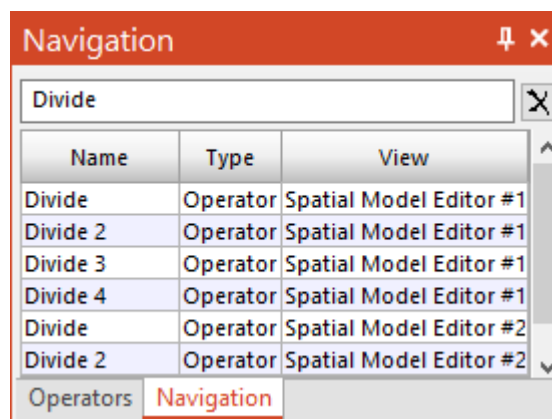

A Navigation panel is now provided to assist in searching and finding specific operators within a Spatial Model and driving to their locations. This is particularly useful when building and testing very large and complex models.

The Mouse Cursor Reflects if a GUI is Available

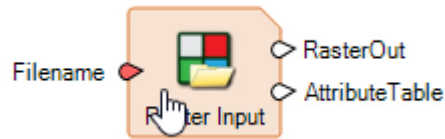

The mouse pointer will now change from the regular pointer to a hand icon if moved over a Port or Operator that can be double-clicked to invoke a dialog.

Open Non-spatial Model/Operator Outputs in a Dialog

For example, in the Spatial Model shown above for the Get Dictionary Names operator, we had this model:

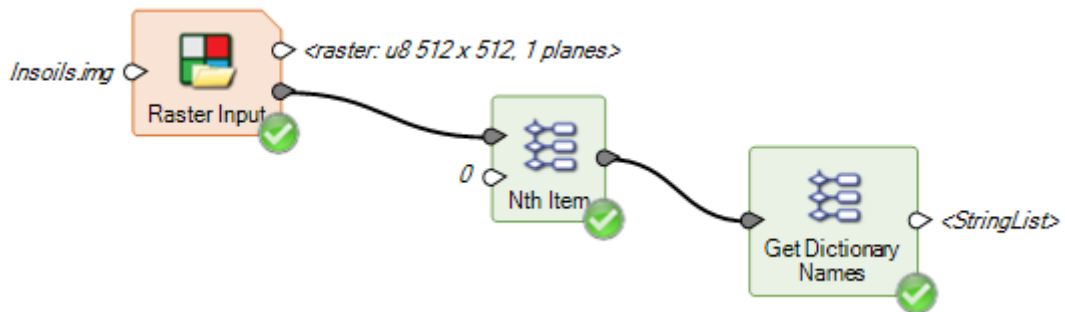

The user can now right-click on the output Names port (which by default just shows <StringList>), select View Data..., and see the attribute field names for the input raster:

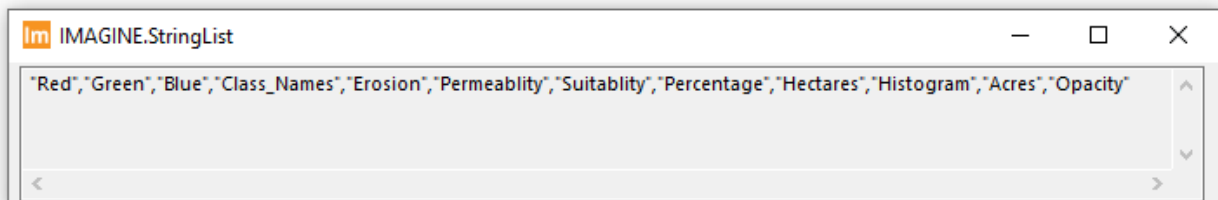

This is useful for quickly checking that your Spatial Model is producing the expected information on a specific output port.

Connect Two Widely Separated Operator Ports

When building large, complex models, you often find yourself adding a new operator on the right side of the model, which requires inputs from several other operators. Some of them might be close, by but others might be all the way back on the left side of the model. Connecting such widely separated operators can be a cumbersome task, usually involving moving the new operator back and forth.

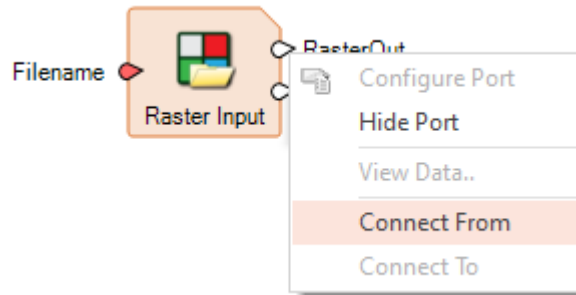

With Spatial Modeler 2022, right-click menus on ports provide two new options: Connect From and Connect To. This enables the person constructing the complex model to right click on an input port of that new operator on the right of the model and pick Connect To, and then scroll over to the left of the model, right click on the appropriate output port and select Connect From, and the two widely separated operators will be connected.

Align Operators Functions

To assist in organizing your spatial models, a new set of alignment tools have been provided.

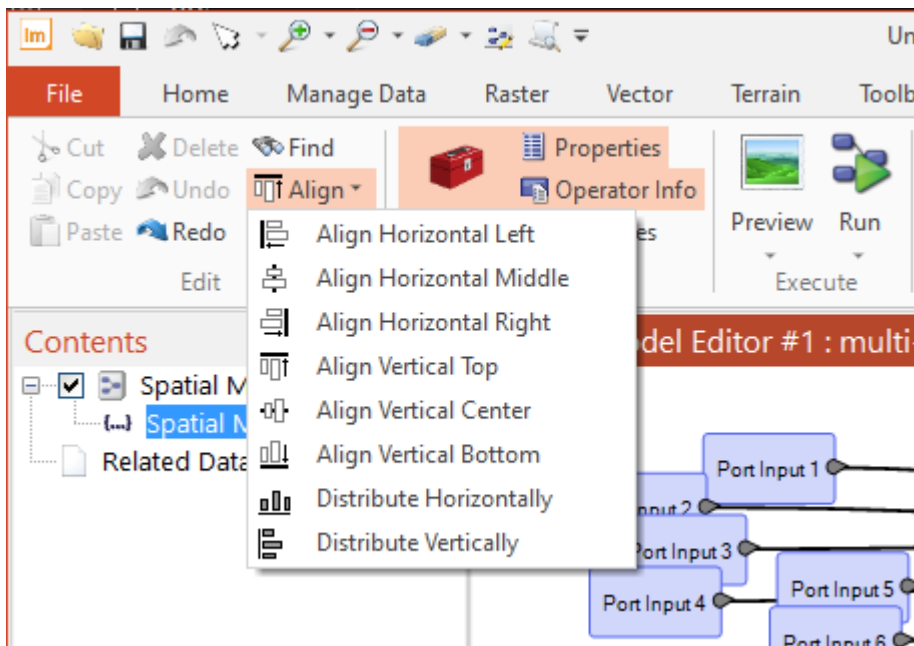

These enable you to quickly reorganize selected operators from something that looks like this:

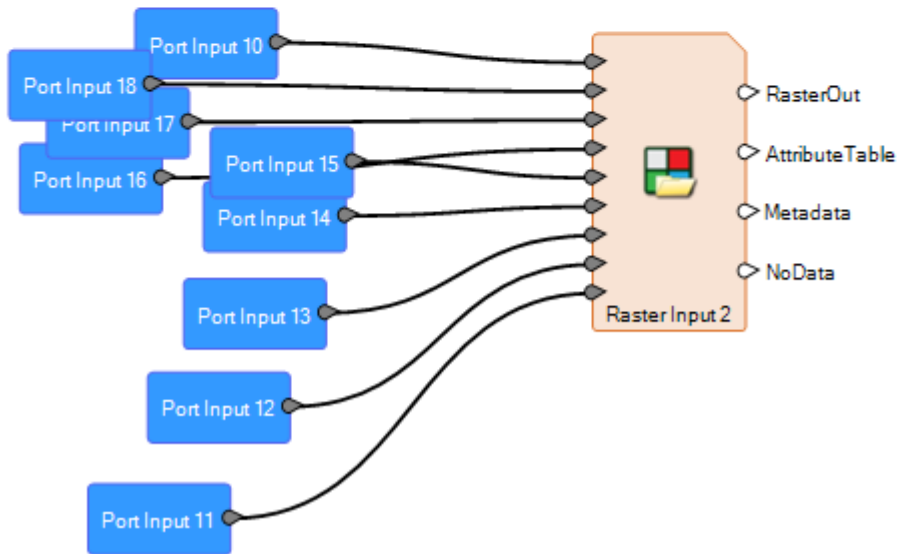
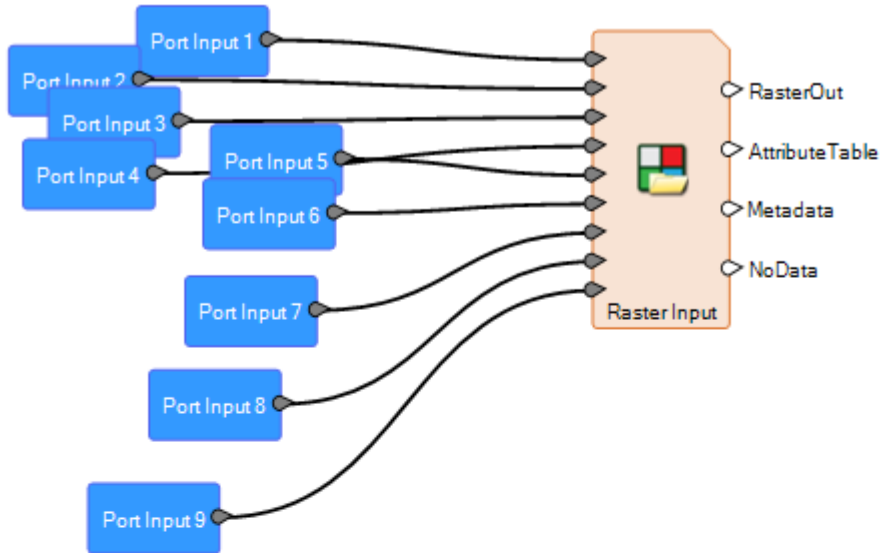

To this, using Align Horizontal Left and then Distribute Vertically:

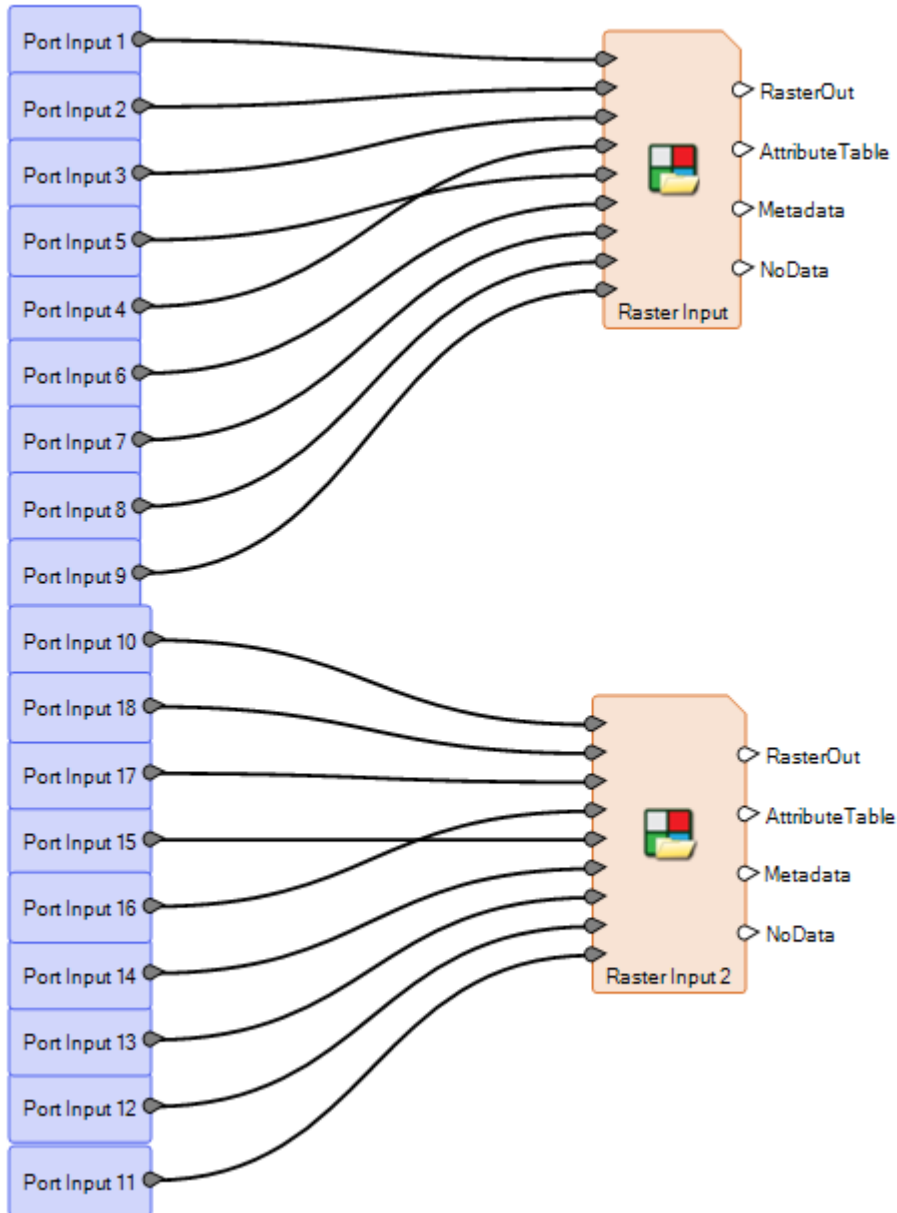

Save As to Python script

As well as being able to use Python scripts within a Spatial Model (for example, via the Python Script operator), you have also been able to use Spatial Model operator within Python Scripts. This latter capability has been made easier with the ability to directly save a Spatial Model to a Python script, which can be used as-is or modified with other Python capabilities.

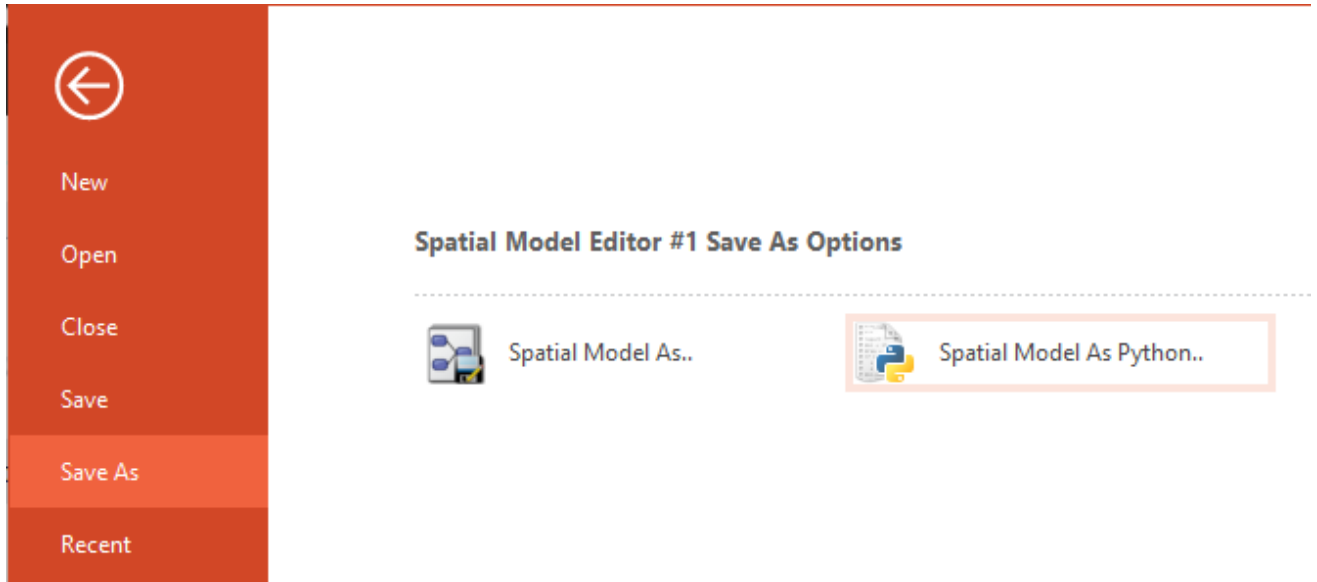

Center Dialogs on Same Screen as Spatial Model Editor

ERDAS IMAGINE and Spatial Model Editor have always supported being opened on any configured display screen. However, some dialogs that were invoked (such as a Run dialog) would appear on the primary display even if called from a secondary display, causing some confusion. Spatial Model Editor has been updated in an effort to ensure that all dialogs appear on the same display as they were called from.

Format Support

Landsat 4, 5, 7, and 8 from USGS

The USGS has begun producing Collection 2 data for the Landsat program via the EarthExplorer service. Unlike older products (which are also still available for download), which were delivered as .tar.gz files, the Collection 2 data is delivered as .tar files, with several other formatting changes.

Consequently, the Landsat 4, 5, 7 and 8 from USGS importer dialog has been overhauled to accommodate the new Collection 2 data, as well as several other changes in the types of data made available for download from EarthExplorer. The changes should also make the importer Landsat 9 ready, but of course there is not yet any data available against which to verify this.

JPEG 2000 NoData Mask

ERDAS IMAGINE has previously always included a NoData mask (also sometimes referred to as an alpha channel) when creating JPEG 2000 (JP2) format files. However, some customers expressed concerns over the inclusion of the NoData mask (because apparently some other geospatial softwares cannot interpret the format correctly), and so an option has been added to specify to *not* add the NoData mask.

This option is available in the JPEG 2000 Exporter dialog, as well as there being a Preference to control the behavior when writing directly to JP2. The Spatial Modeler's Get JPEG 2000 Options operator has also been enhanced with a port to allow control of the mask creation on output.

DIMAP v2

DIMAP v2 formatted satellite imagery (such as Pleiades and SPOT 7) should now open and display more efficiently.

SRTM HGT

SRTM HGT elevation data is now readable in Spatial Modeler, as well as being displayable via the Image Chain rendering engine in 2D Views.

Esri File Geodatabase

Esri File Geodatabase (*.fgd) vector features are now readable in Spatial Modeler, as well as being displayable in 2D Views.

SIDD 1.1

The SIX SICD/SIDD libraries, as well as the SIDD schema files, have been updated to add support for SIDD 1.1

NITF

SECURA TRE is now decoded.

Reading and displaying JPEG 2000 encoded NITF imagery that has more than three bands (such as 8-band WorldView-2) has been parallelized for greater efficiency.

Features from S3 Bucket

Previously, support had been added for raster data available in S3 buckets. This has now been extended to include vector features such as shapefiles.

General ERDAS IMAGINE

SIPS v2.4.16

We have updated the installer to use the Unclassified SIPS v2.4.16 XML file to control default Image Chain display parameters.

You can acquire extended versions of SIPS via the IMAGINE Defense Productivity Module (DPM) or by replacing the appropriate XML file.

Inquire Box Improvements

The Inquire Box now more accurately visually depicts the “file rectangle” encompassed by the box on geometrically calibrated or rotated imagery. This means that when performing operations such as a Subset or Chip, the box better represents the area that you will see in the output.

Filename Case Retention

Previously, ERDAS IMAGINE and Spatial Model have always converted any filenames entered for new output files into all lowercase (even though the software could recognize and ingest filenames that used mixed case). This has been corrected to retain the case you specify.

For example, if you specify you want an output file called “AluminiumOreLocations.img” you will now get a file called “AluminiumOreLocations.img.”

File Chooser Improvements

The File Chooser has been improved in several different ways. It now remembers settings for size, it provides more and easier to understand actions for the current folder, it introduces a Detail view to provide more information about the files in the current view, and it provides access to the recently visited folders in the folder pulldown menu.

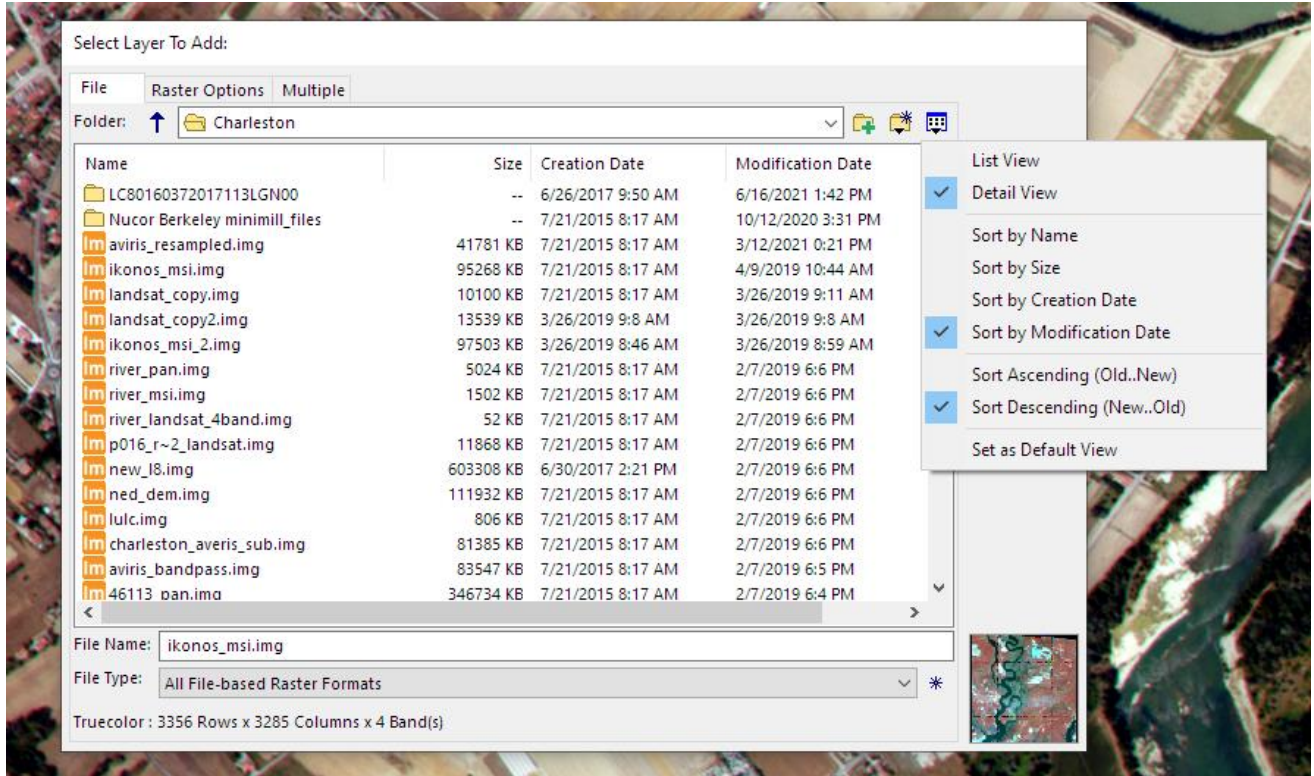

The last size of the dialog is remembered (by automatic recording to a User Preference) and recalled whenever the dialog is opened. If you prefer a larger view, just stretch the dialog once, and it will come back the same size the next time the dialog is opened.

In addition to setting the current folder as the Default Input or Default Output folder, the path to the current folder can be copied to the copy/paste buffer for use in other places, and the current folder can be opened in the Windows File Explorer.

The Folder pulldown list has several improvements. It provides two new shortcuts to the Desktop and to the Downloads folder, as these are commonly the location of newly received data. It also provides the list of recently visited folders so that going to a previous folder is now a simple two-click operation.

A Detail view has been added that shows the name, size, creation date, and modification date of files (sizes are not available for folders). The view can be sorted by any of these fields in ascending or descending order. There is a new button that displays the menu from which these settings are made. The view mode is saved (for the current session) for each of the folders visited and will be used whenever that folder is viewed again from within the current session. The view settings can be saved and will become the default view.

GPU Acceleration

Several operators in Spatial Modeler have been reimplemented to use GPU acceleration (usually CUDA-based) to increase the efficiency and reliability of execution.

For example, the Compute GLCM Texture operator has been reimplemented in CUDA rather than OpenCL, leading to more reliable usage of available memory for accelerated processing.

The Enhance Contrast Using CLAHE operator has been re-implemented to use GPU acceleration. Tests have shown the new operator to be more than 15 times faster than the prior version.

The following Focal operators have also been refactored:

- Focal Min
- Focal Max
- Focal Mean
- Focal Standard Deviation
- Focal Majority
- Focal Minority

The Fuzzy Convolution tool was also refactored, but little difference was seen between the GPU and CPU implementations. However, the new CPU implementation proved to be more than three times faster than the old implementation.

Projected Coordinate Systems (PCS)

The following PCS have been added or enhanced:

- EPSG codes for Portuguese islands (EPSG 5013, 5014, 5015, and 5016) have been added.
- GEOID18 has been added.
- Puerto Rico Vertical Datum of 2002 (PRVD02) has been added.
- Virgin Islands Vertical Datum of 2009 (VIVD09) has been added.
- ITRF2014, the new realization of the International Terrestrial Reference System, is now supported.

MosaicPro

Active areas computed using the Edges method can now be cropped.

SAR Functionality

Radar imagery continues to be a growing and important source of geospatial information and remains an area of development for Hexagon. In ERDAS IMAGINE 2022, we have added the following capabilities:

Beta 0

The Beta 0 radiometric conversion is now supported for most common commercial radar sensors.

Sigma 0

The Sigma 0 radiometric conversion is now supported for most common commercial radar sensors.

E-Z Coherence Change

The E-Z Coherence Change tool now allows selection of which products to generate (ILU, Coherence Texture, or Multi Temporal Coherence) rather than generating them all, allowing more efficient processing for just the information of interest.

Sentinel-1 GRD

Previously, Sentinel-1 GRD products used the relatively inaccurate georeferencing information embedded in the TIFF file. The software has been enhanced to create a SAR sensor model using the header information for more accurate georeferencing.

Sentinel-1 Image Formation

An improved algorithm for assembling bursts into a single continuous image has been implemented.

Capella

The Capella SAR sensor model has been updated to use the header information provided by the most recently acquired example imagery. Positional accuracy is improved to +/- 1 pixel in most cases.

The Capella format reader now supports the GEC product in JSON format and data in the SICD format.

The Coregister Radar Images tool now works with Capella GEO data.

Capella SLC files will now open as Magnitude and Phase components and can be used for interferometric processing.

ICEYE

ICEYE SLC files (in HDF5 format) will now open as Magnitude and Phase components and can be used for interferometric processing.

COSMO SkyMed Second Generation (CSG)

CSG imagery can be read and displayed.

System Requirements

ERDAS IMAGINE

Computer/ Processor	64-bit: Intel 64 (EM64T), AMD 64, or equivalent (four or more logical processors are strongly recommended)
Memory (RAM)	16 GB or more strongly recommended
Disk Space	<ul style="list-style-type: none"> 6 GB for software 7 GB for example data Data storage requirements vary by mapping project¹
Operating Systems ^{2, 3, 4}	<ul style="list-style-type: none"> Windows 10 Pro (64-bit) Windows 10 Enterprise (64-bit) Windows Server 2019 (64-bit) Windows Server 2022 (64-bit) Windows 11 Enterprise (64-bit) (Windows Insider Program pre-release version)
Software	<ul style="list-style-type: none"> OpenGL 2.1 or higher (this typically comes with supported graphics cards⁵) Java Runtime 1.7.0.80 or higher — IMAGINE Objective requires JRE and can utilize any installed and configured JRE of version 1.7.0.80 or higher. Microsoft Visual C++ 2010 x64 Redistributable is also required. Python 3.7.x (Python is optionally usable with Spatial Modeler) Microsoft DirectX[®] 9c or higher .NET Framework 4.7.2 or higher OpenCL 1.2 with a device that supports double precision (cl_khr_fp64) if wanting to GPU accelerate NNDiffuse and other Operators An NVIDIA card with CUDA capabilities is recommended for use with Deep Learning and other Operators
Recommended Graphics Cards for Stereo Display ⁶	<ul style="list-style-type: none"> NVIDIA[®] Quadro[®] P6000, P5000, P4000, P2000 NVIDIA[®] Quadro[®] M6000, M5000, M4000, M2000 NVIDIA[®] Quadro[®] K5200, K5000, K4200, K4000, K2200, K600, K420 NVIDIA Quadro RTX4000
Recommended Stereo Display Monitors	<ul style="list-style-type: none"> 120 Hz (or above) LCD Monitors with NVIDIA 3D Vision™ Kit, or 3D PluraView system from Schneider Digital⁷ Vision Engineering CONTOUR 3D stereoscopic GIS display
Recommended Stereo Glasses and Emitter kits	<ul style="list-style-type: none"> NVIDIA 3D Vision™ Kit 3DTV Universal Emitter
Peripherals	<p>All software installations require:</p> <ul style="list-style-type: none"> One Windows-compatible mouse with scroll wheel or equivalent input device Printing requires Windows-supported hardcopy devices⁸ <p>Software security (Hexagon Geospatial Licensing 2022) requires one of the following:</p> <ul style="list-style-type: none"> Ethernet card, or One USB port for hardware key <p>Advanced data collection requires one of the following hand controllers:⁹</p> <ul style="list-style-type: none"> TopoMouse™ or TopoMouse USB™ Immersion 3D Mouse MOUSE-TRAK

	<ul style="list-style-type: none"> Stealth 3D (Immersion), S3D-E type, Serial Port Stealth Z, S2-Z model, USB version Stealth V, S3-V type (add as a serial device) 3Dconnexion SpaceMouse Pro¹⁰ 3Dconnexion SpaceExplorer mouse¹⁰ Z/I Mouse
ArcGIS and GeoMedia Interoperability	<ul style="list-style-type: none"> ERDAS IMAGINE can be safely installed on a computer that has GeoMedia 2020 or GeoMedia 2022 installed; however, for greatest compatibility, it is highly recommended to install matching versions (including updates). ERDAS IMAGINE 2022 requires GeoMedia 2022 for live linking. Order of installation does not matter. ERDAS IMAGINE can interact with File Geodatabases. ERDAS IMAGINE can be safely installed on a computer that has ArcGIS® versions 10.6 through 10.8.1 (but ArcGIS installation is not required for File Geodatabase access).
Database Engines	<ul style="list-style-type: none"> PostgreSQL 13.2 with PostGIS 3.1.1: PostGIS can be used to store GeoMedia Features (.fpf) Oracle Server 19c (12.2.0.3) 64-bit: Oracle Server 19c can be used to store Oracle GeoRaster (.ogr) (requires Oracle Spatial), SDE Raster (.sdi) (requires ArcGIS for Server) and Oracle Spatial Features (.ogv) (requires Oracle Spatial), as well as GeoMedia Features (.ofp). Microsoft SQL Server 2019 64-bit: Microsoft SQL Server 2019 can be used to store GeoMedia Features (.sfp)

ERDAS IMAGINE System Requirements Notes

¹ Disk I/O is usually the slowest task in geospatial data processing. Faster hard disks improve productivity. Reading data from one disk, writing temporary data to a second disk, and writing data to a third disk improves performance. Disk arrays improve productivity, but some RAID options slow performance. Network disk drives are subject to network limitations.

² Server Operating Systems are not supported for IMAGINE Photogrammetry, ORIMA, or ERDAS ER Mapper.

³ The 3D stereo viewing and peripheral requirements of IMAGINE Photogrammetry limit its operating system options.

⁴ Includes ERDAS ER Mapper support.

⁵ Windows provides a generic OpenGL driver for all supported graphics cards; however, an OpenGL-optimized graphics card and driver are recommended for these applications.

⁶ Graphics cards certified with previous versions of IMAGINE Photogrammetry and ORIMA may also be compatible but are not certified in the current version. Drivers must not be newer than R418. NVidia dropped 3D Vision support for drivers released after R418 U4 (425.31), which was released on April 11, 2019.

⁷ Stereo Monitors certified with previous versions of IMAGINE Photogrammetry and ORIMA may also be compatible but are not certified in the current version.

⁸ HP-RTL drivers are recommended. Windows 64-bit print servers require 64-bit print drivers.

⁹ Stealth S-Mouse (S2-S model) and MOUSE-TRAK are the only supported hand controllers in Stereo Analyst for ERDAS IMAGINE.

¹⁰ 3Dconnexion mice are supported in IMAGINE Photogrammetry.

Issues Resolved – ERDAS IMAGINE 2022

IMAGINE Essentials

Support Ticket	Summary – IMAGINE Essentials
00058100	Save Top Layer As... a raster edit to output ECW no longer crashes ERDAS IMAGINE Raster Editing an image (of any input format) and trying to Save to an ECW file would cause a crash. In-place editing of ECW format files is not possible, so the application will now prompt the user to save to a different format.
00062459	Can now add multiple Sentinel-2 (S2*_SAFE) images to the Batch tool "Directory-style" datasets such as Sentinel-2 SAFE were not previously supported by the Batch tool, which generally expects files as inputs. This has been corrected.
00053629	The JPEG 2000 exporter no longer throws the error "Not Implemented" for some geometrically calibrated (georeferenceable) input images.
00020234	The "Pixels to ASCII" tool no longer drops the first row in the output if an AOI is used that was created from a Shapefile.
00010750	The Generic Binary (Direct Read) importer now works on input data with Byte Order INTEL
00010936	The "Create Compression Report" checkbox is now working with the JPEG2000 Export GUI tool. If unchecked the report is now not created.
00014237	If attempting to export a very large JPEG 2000 image to another format (such as .ers) and the input image is corrupt, the exporter will now issue a warning that the input is corrupt to the Session Log.
00077031	In prior versions, attempting to open a NITF with "attached" segments (determined by IDLVL, IALVL) that have differing numbers of bands would cause warning messages. Instead, the new release will detect that data is associated, but if it has differing numbers of bands from the "parent" will not attempt to form a virtual mosaic of the data.
00015832	The Snap to Pixel option no longer fails in the Inquire Box tool when using geometrically calibrated (georeferenceable) Lat/Long data.
00082660	Save As > All layers as NITF no longer fails when adding multiple geometrically calibrated (georeferenceable) images.
00079396	ERDAS IMAGINE no longer crashes when opening .las files which are missing projection information.
00074827	In prior versions the Image Chain menu behaved unexpectedly when using the mouse-wheel to scroll through the menu choices. The menu would jump all the way to the bottom when you scrolled down. This made it appear that the Radar option was missing from the menu. This has been corrected.
00031644	On screens where Windows Scaling was set to something other than 100% undocked panels could sometimes be difficult to move and redock due to their selector being drawn in the incorrect location. This has been corrected.
00070496	The software no longer crashes when clicking on the Vector Options button under certain circumstances.
00074296	ERDAS IMAGINE no longer attempts to build pyramid layers for WMTS data coming from an APOLLO server and therefore no longer crashes.

IMAGINE Advantage

Support Ticket	Summary – IMAGINE Advantage
00078821	No longer receive error message "Args" during MosaicPro Project Creation when selecting "Use Entire Image" or "Crop Area By" under the Tab "Image Area Options" (Block Image Type: Images).
00031073	Radar imagery can now be orthorectified using GCPs measured via the standard GCP Editor (with the SAR sensor model). The deprecated "OrthoRadar Classic" tools have been removed since they are no longer required.
00079242	Some Sentinel-1 scenes with LMX formatting could no longer be opened in ERDAS IMAGINE after applying orbit correction. This has been corrected.
00079107	The Viewshed tool was writing the incorrect color legend order to the 2D View's Contents legend pane. The correct color hues were used but were arranged in an offset order when compared to the legend order created in the Viewshed tool itself. This has been corrected.

IMAGINE Objective

Support Ticket	Summary – IMAGINE Objective
00074391	Online Help for IMAGINE Objective has been enhanced to better explain its use in the Batch Tool.
00062294	IMAGINE Objective no longer crashes when adding Raster Pixel Processor queues to a project on a system which does not have Java installed.
00066707	The IMAGINE Objective Root Folder assignment now always follows the Root Folder dialogue input
00072723	Sometimes the IMAGINE Objective process would stop at the Vector Object Processor (VOP) step due to being unable to delete temp files. This has been corrected.
00074235	Documentation which erroneously referred to an 'Edges' pixel cue has been removed since that cue is not available.

IMAGINE Photogrammetry

Support Ticket	Summary – IMAGINE Photogrammetry
00046100	Import tool now imports INPHO project with correct flying height.
00078277	Error "Not enough points" no longer occurs when inserting SkySat RPC stereo images to block
00076470	IMAGINE DSM Extractor is now working as designed in Smooth mode for extracting surface heights from stereo satellite imagery. A Sharp mode will be added in a future release.
00077513	A problem has been corrected whereby IMAGINE DSM Extractor would fail when processing satellite stereo pairs that had irregular outlines.
00067210	Stereo Analyst for IMAGINE no longer crashes when the Digitizing Device is set to ABC Puck

IMAGINE Professional

Support Ticket	Summary – IMAGINE Professional
00082993, 00079027, 00072928	<p>Knowledge Classification not working (in 64-bit)</p> <p>Knowledge Classification had not previously been correctly implemented in 64-bit (but worked fine in 32-bit). Since ERDAS IMAGINE 2022 is only available as a 64-bit implementation this has been corrected.</p>
00078622	Signature Editor no longer crashes when reading a shapefile with polygons located outside the image extent.
00080431	Accuracy Assessment Tool no longer crashes when trying to generate an Accuracy Report in a 64-bit version of ERDAS IMAGINE
00064184	Image Alarm now works in 64-bit version of ERDAS IMAGINE and produces correct results.
00081864	Unsupervised Classification now works if \$HOME variable set to an unavailable drive. The software now uses the temporary file folder specified in Preferences.
00065318	Help for Classify using Machine Learning (trained using the SVM algorithm) has been improved to clarify that data attributes cannot be of different formats (such as float and integer).
00068952	Merging spectrum signatures in the Materials List panel or the Archive Libraries panel could cause the Spectral Analysis Workstation to crash. This has been corrected.
00073803	The documentation for Subpixel Preprocessing has been updated to indicate that Float is not a supported input data type, and the software has been modified to prevent a crash if you attempt to use Float data.

Spatial Modeler

Support Ticket	Summary – Spatial Modeler
00072810	The “Update Image with RPC” operator no longer fails for WorldView RPC data
00012069	The Create Color Ramp operator no longer produces output values that are outside the valid range of a Color definition.
00055402	The Features Input operator “Connection Manager” dialog was incorrectly reporting Geometry Type for a Compound feature class. This has been corrected.
00077570	Running a Spatial Model where an apply AOI operator has been placed inside an iterator, and with a Port Input outside the iterator (to input the AOI), no longer fails.
00074810	An Object Detection model to generate a machine intellect no longer hangs when using Machine Learning Layout training type “Object Footprints Only.”
00082538	The Convert to Features operator would sometimes produce invalid geometry, primarily due to non-conformance with the rule that polygon rings must be closed by repeating the first vertex coordinate as the last coordinate of the ring. This has been corrected.

ERDAS ER Mapper

Support Ticket	Summary – Spatial Modeler
00078899	ERDAS ER Mapper had been reporting pixel values that were double the actual value for Sentinel-2 u16 JPEG 2000 data. This has been corrected.

Contact Us

 <https://go.hexagongeospatial.com/contact-us-today>

About Hexagon

Hexagon is a global leader in digital reality solutions, combining sensor, software and autonomous technologies. We are putting data to work to boost efficiency, productivity, quality and safety across industrial, manufacturing, infrastructure, public sector, and mobility applications.

Our technologies are shaping production and people-related ecosystems to become increasingly connected and autonomous – ensuring a scalable, sustainable future.

Hexagon's Safety, Infrastructure & Geospatial division improves the performance, efficiency and resilience of vital services. Its Safety & Infrastructure solutions enable smart and safe cities. Its Geospatial software leverages the power of location intelligence.

Hexagon (Nasdaq Stockholm: HEXA B) has approximately 21,000 employees in 50 countries and net sales of approximately 3.8bn EUR. Learn more at hexagon.com and follow us [@HexagonAB](https://twitter.com/HexagonAB).

Copyright

© 2021 Hexagon AB and/or its subsidiaries and affiliates. All rights reserved

Warning: The product made the subject of this documentation, including the computer program, icons, graphical symbols, file formats, audio-visual displays and documentation (including this documentation) (collectively, the “Subject Product”) may be used only as permitted under the applicable software license agreement, and subject to all limitations and terms applicable to use of the Subject Product therein. The Subject Product contains confidential and proprietary information of Intergraph Corporation, a member of the Hexagon Group of companies (“Hexagon”), its affiliates, and/or third parties. As such, the Subject Product is protected by patent, trademark, copyright and/or trade secret law and may not be transferred, assigned, provided, or otherwise made available to any third party in violation of applicable terms and conditions cited further below.

Terms of Use

By installing, copying, downloading, accessing, viewing, or otherwise using the Subject Product, you agree to be bound by the terms of the EULA found here: https://www.hexagonsafetyinfrastructure.com/-/media/Legal/Hexagon/SI/Licenses/EULA_SA_SIG-Eng_062021.pdf.

Disclaimers

Hexagon and its suppliers believe the information in this publication is accurate as of its publication date. Hexagon is not responsible for any error that may appear in this document. The information and the software discussed in this document are subject to change without notice.

Language Translation Disclaimer: The official version of the Documentation is in English. Any translation of this document into a language other than English is not an official version and has been provided for convenience only. Some portions of a translation may have been created using machine translation. Any translation is provided “as is.” Any discrepancies or differences occurring in a translation versus the official English version are not binding and have no legal effect for compliance or enforcement purposes. Hexagon disclaims any and all warranties, whether express or implied, as to the accuracy of any translation.

Reasonable efforts have been made to provide an accurate translation; however, no translation, whether automated or provided by human translators is perfect. If any questions arise related to the accuracy of the information contained in a translated version of Documentation, please refer to its official English version. Additionally, some text, graphics, PDF documents, and/or other accompanying material may not have been translated.

Links To Third Party Websites

This Document may provide links to third party websites for your convenience and information. Third party websites will be governed by their own terms and conditions. Hexagon does not endorse companies or products to which it links.

Third party websites are owned and operated by independent parties over which Hexagon has no control. Hexagon shall not have any liability resulting from your use of the third party website. Any link you make to or from the third party website will be at your own risk and any information you share with the third party website will be subject to the terms of the third party website, including those relating to confidentiality, data privacy, and security.

Hexagon provides access to Hexagon international data and, therefore, may contain references or cross references to Hexagon products, programs and services that are not announced in your country. These references do not imply that Hexagon intends to announce such products, programs or services in your country.

Revisions

Hexagon reserves the right to revise these Terms at any time. You are responsible for regularly reviewing these Terms. Your continued use of this Document after the effective date of such changes constitutes your acceptance of and agreement to such changes.

Questions

[Contact us](#) with any questions regarding these Terms.